

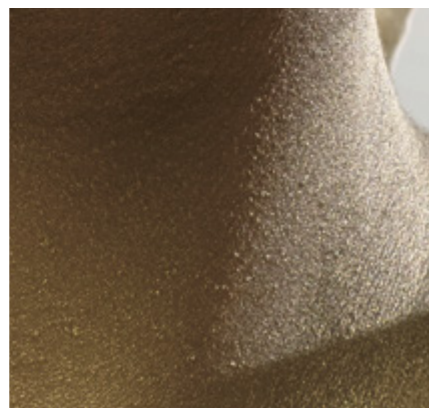

Sanitana

Sanitana

The logo for Sanitana features the word "Sanitana" in a blue, sans-serif font. Below the letters "n" and "a" is a green, stylized swoosh that curves upwards and then downwards, resembling a checkmark or a smile.

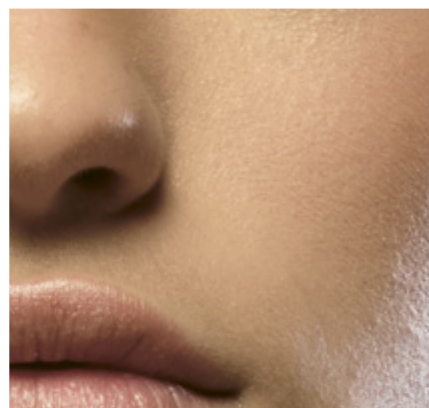

ÍNDICE

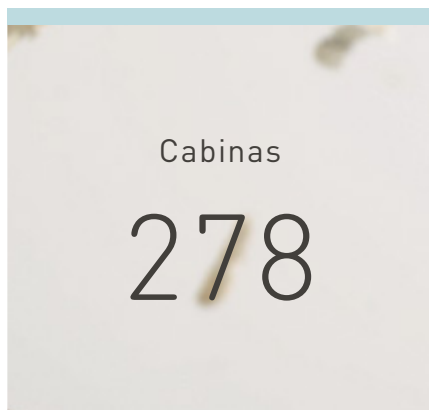
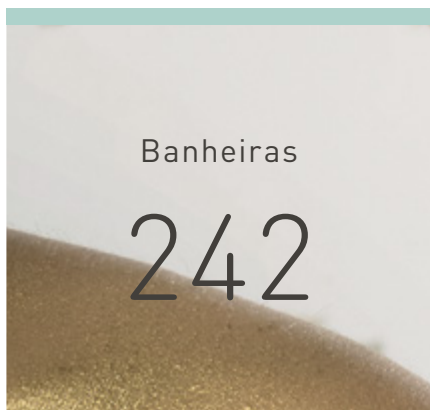
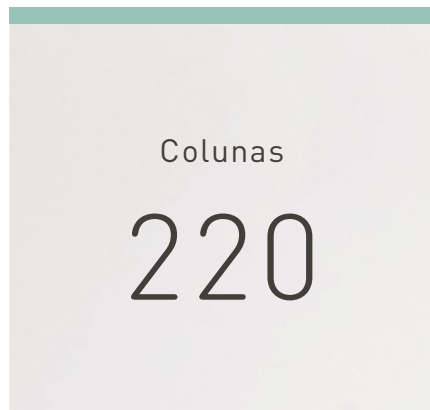
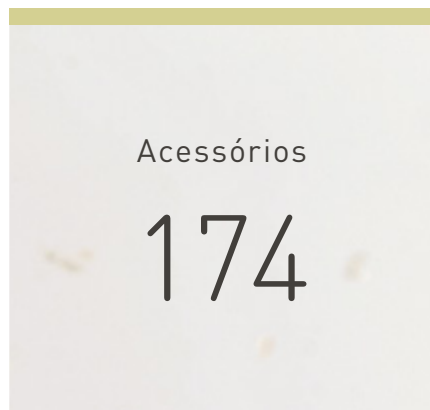
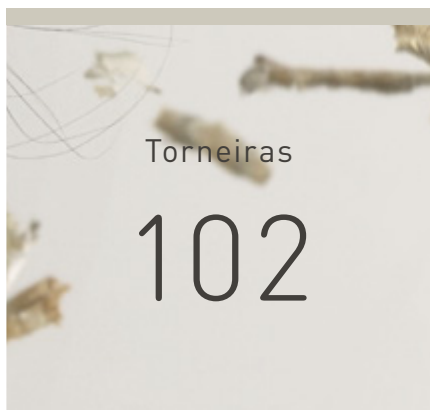
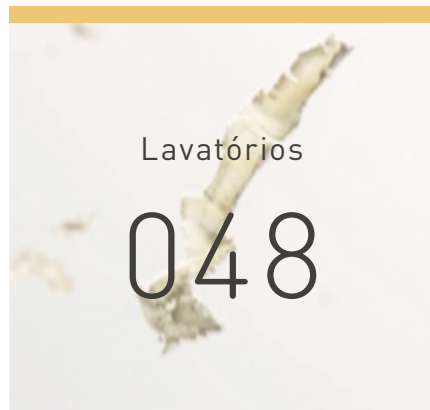
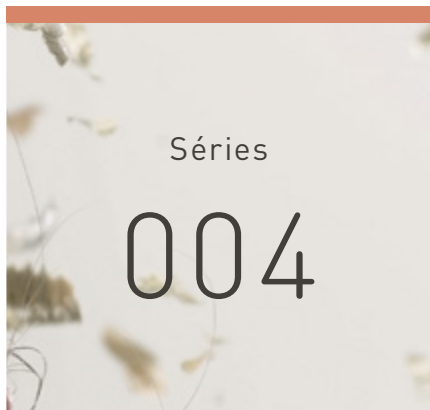

POUPANÇA

Para que possa reduzir o consumo de água na sua habitação, os nossos tanques de sanita são equipados com pulsadores de descarga dupla, permitindo o controlo da quantidade de água utilizada para a limpeza da sanita. A limpeza poderá ser feita em 2 modalidades: 6/3L ou 4,5/3L.

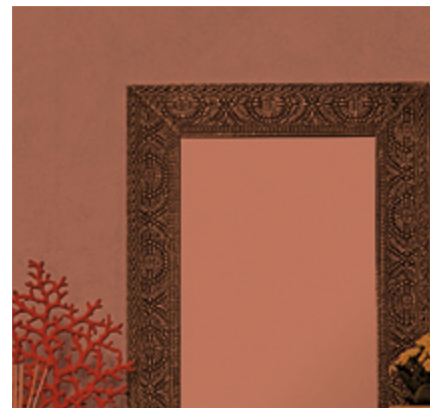

SÉRIES DE BANHO

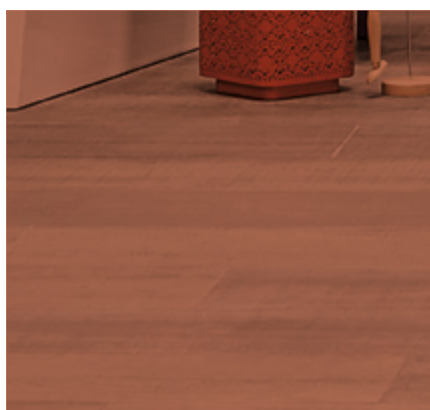

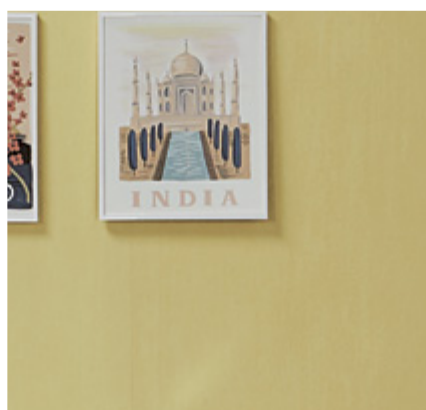
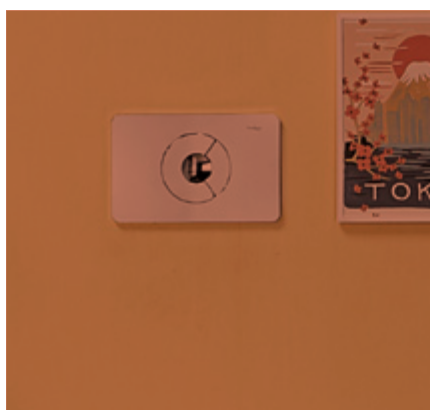
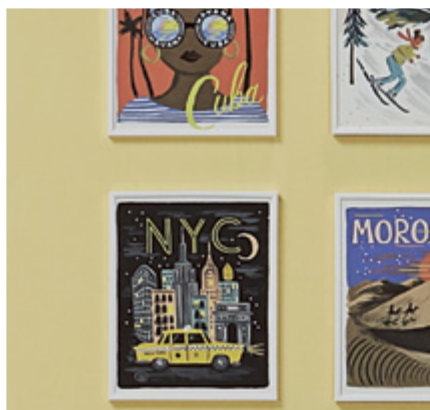

PERFORMANCE

A nossa gama de tampos com sistemas de queda amortecida é cada vez mais vasta, oferecendo versões específicas para sanitas e bidés. As dobradiças especiais que os equipam permitem uma queda progressiva do tampo, conferindo mais durabilidade e segurança.



DESIGN E ECONOMIA

As nossas linhas cerâmicas sanitárias foram pensadas para lhe proporcionar o máximo de qualidade, conforto e segurança. Os nossos desenhos são plenos de riqueza visual, plenamente acessíveis e que adicionalmente integram sistemas que lhe permitem a poupança de água.



BE YOU

COMPACTA BTW
COMPACTA
SIMPLES BTW
SUSPENSA



Sanita e bidê suspenso BE YOU 50 de encastre com torneira BALANCE e acessórios CONNECT

+ BE YOU

TIPOLOGIAS:

Compacta BTW / Compacta /
Simples BTW / Suspensa

CORES:

Branco

CARACTERÍSTICAS:

Com descarga dual ecológica

Tampas de sanita disponíveis em:

termodur com ou sem queda amortecida

Lavatórios murais 60, 55, 40 e 40 de canto

Lavatórios de pousar 60, 55 e 40

Lavatórios de encastre 60 e 50



Lavatório BE YOU 60 de encastre com torneira BALANCE

N
O
V
I
D
A
D
E



Banheira QUEEN com painel integral e torneira BALANCE

1 Sanita Compacta BTW

MEDIDAS:
640 x 370 x 790mm
CARACTERÍSTICAS:
Descarga dual 4,5/3l



2 Sanita Compacta

MEDIDAS:
640 x 370 x 780mm
CARACTERÍSTICAS:
Descarga dual 4,5/3l



3 Sanita Simples BTW

MEDIDAS:
545 x 370 x 400mm
CARACTERÍSTICAS:
Descarga dual



4 Sanita Suspensa

MEDIDAS:
540 x 370 x 400mm



Bidé e sanita simples BTW BE YOU com torneira BALANCE para bidé

5 Lavatórios De pousar

MEDIDAS:

60: 600 x 430 x 165mm

55: 550 x 430 x 165mm

40: 400 x 430 x 165mm



6 Lavatórios Murais

MEDIDAS:

60: 600 x 430 x 165mm

55: 550 x 430 x 165mm

40: 400 x 430 x 165mm

40 canto: 420 x 460 x 170mm



Sanita e bidé compactos BE YOU com torneira UNIC

7 Lavatórios De Encastre

MEDIDAS:

60 com furo: 630 x 400 x 120mm (assimétrico)

60 com furo: 600 x 460 x 120mm

50 com furo: 500 x 460 x 120mm

60 sem furo: 600 x 350 x 120mm

50 sem furo: 500 x 350 x 120mm





Lavatório de encastre assimétrico BE YOU 60

8 Bidé BTW

MEDIDAS:
540 x 370 x 400mm

**9 Bidé Suspenso**

MEDIDAS:
540 x 370 x 400mm



Lavatório de encastre BE YOU 50 com torneira BLOC para lavatório

+ CORAL

TIPOLOGIAS:

Compacta BTW

Simples BTW

Suspensa

CORES:

Branco

CARACTERÍSTICAS:

Com descarga dual ecológica

Tampos de sanita disponíveis em:

termodur com ou sem queda amortecida

termodur SLIM com queda amortecida



Sanita simples BTW CORAL com tampo SLIM e bidé CORAL



Sanita compacta e bidé BTW CORAL

1 Lavatórios

APLICAÇÃO:

De pousar / Murais

MEDIDAS:

65: 650 x 430 x 168mm

57: 570 x 430 x 168mm



SUSPensa
SIMPLES BTW
COMPACTA BTW

CORAL



Lavatórios MIXMI 57 com torneiras UNIC

2 Sanita Compacta BTW**MEDIDAS:**

620 x 370 x 780mm

CARACTERÍSTICAS:

Descarga dual 4,5/3l

**3 Sanita Simples BTW****MEDIDAS:**

560 x 360 x 400mm

CARACTERÍSTICAS:

Descarga dual

**4 Sanita Suspensa****MEDIDAS:**

555 x 365 x 405mm

**5 Bidé BTW****MEDIDAS:**

540 x 360 x 395mm

**6 Bidé Suspenso****MEDIDAS:**

555 x 360 x 400mm



Sanita e bidé suspensos CORAL com torneira UNIC e placa de comando ARC

1 Lavatório De pousar

MEDIDAS:
55: 560 x 420 x 165mm



2 Lavatório De encastre

MEDIDAS:
70: 700 x 465 x 155mm



3 Sanita Compacta BTW

MEDIDAS:
600 x 365 x 785mm
CARACTERÍSTICAS:
Descarga dual 4,5/3l



4 Bidé BTW

MEDIDAS:
530 x 365 x 400mm



5 Sanita Suspensa

MEDIDAS:
525 x 365 x 405mm



6 Bidé Suspenso

MEDIDAS:
530 x 365 x 400mm



Sanita e bidé suspensos GLAM com torneira SILK para bidé



Lavatório GLAM 55 em móvel GLAM



+ GLAM

TIPOLOGIAS:
Compacta BTW
Suspensa

CORES:
Branco

CARACTERÍSTICAS:
Com descarga dual ecológica
Tampas de sanita e bidé disponíveis em:
termotur com ou sem queda amortecida



GLAM

COMPACTA BTW
SUSPENSA



Lavatório e móvel GLAM 70 em wengué, sanita e bidé compacto BTW GLAM com torneiras SILK



Bidé e sanita compacta BTW Short NEXO com torneira FLOW para bidé e porta-rolô CONNECT Round

1 Lavatórios

APLICAÇÃO:
Murais ou de encastre
CARACTERÍSTICAS:
Gama com 7 modelos:
(ver página 84)

2 Sanita Compacta

MEDIDAS:
665 x 375 x 790mm
CARACTERÍSTICAS:
Descarga dual 6/3l



3 Sanita Short BTW

MEDIDAS:
610 x 380 x 780mm
CARACTERÍSTICAS:
Descarga dual 4,5/3l



4 Sanita Simples BTW

MEDIDAS:
540 x 360 x 390mm
CARACTERÍSTICAS:
Descarga dual



5 Bidé BTW

MEDIDAS:
535 x 360 x 385mm



6 Bidé Simples

MEDIDAS:
565 x 360 x 390mm



7 Sanita Suspensa

MEDIDAS:
535 x 360 x 405mm



8 Bidé Suspenso

MEDIDAS:
525 x 360 x 415mm



NEXO

COMPACTA + SHORT BTW
SIMPLES BTW
SUSPENSA



+ NEXO

TIPOLOGIAS:

Compacta / Short BTW / Simples BTW / Suspensa

CORES:

Branco

CARACTERÍSTICAS:

Com descarga dual (ecológica no modelo *short BTW*)

Tampos de sanita disponíveis em:

termotur com ou sem queda amortecida

Aro de sanita aberto na frente disponível em:

contraplacado lacado adaptado a P.M.R.

Lavatórios compatíveis com coluna e meia coluna NEXO
(exceção: lavatórios de encaixe e lava-mãos)

Bidé e sanita suspensos, lavatório 60 e meia coluna NEXO com torneiras FLOW, placa PLAN e espelho MAYARA

POP ART

COMPACTA BTW
SIMPLES BTW
SUSPENSA

Lavatório SMOOTH com torneira BALANCE, coluna SLIM e base ROCKS quadrada

POP ART

TIPOLOGIAS:

Compacta BTW / Simples BTW / Suspensa

CORES:

Branco

CARACTERÍSTICAS:

Com descarga dual 6/3L

Tampos de sanita disponíveis em:

termodur com ou sem queda amortecida

Lavatórios 62 e 57 compatíveis com:

coluna POP ART

Lavatórios 62, 57 e 50 compatíveis com:

meia coluna POP ART



Lavatório POP ART / KAPA 62 com torneira BALANCE



Bidé e sanita compacta BTW POP ART com torneira BALANCE e acessórios CONNECT

1 Lavatórios

APLICAÇÃO:

De pousar / murais

CARACTERÍSTICAS:

Gama composta por 4 modelos:
(ver página 86)

2 Sanita Compacta BTW

MEDIDAS:

640 x 365 x 790mm

CARACTERÍSTICAS:

Descarga dual 6/3l



3 Sanita Simples BTW

MEDIDAS:

540 x 355 x 400mm

CARACTERÍSTICAS:

Descarga dual



4 Bidé BTW

MEDIDAS:

525 x 360 x 400mm



5 Sanita Suspensa

MEDIDAS:

545 x 360 x 400mm



6 Bidé Suspenso

MEDIDAS:

545 x 360 x 400mm



Bidé e sanita suspensos POP ART com torneira BALANCE e acessórios CONNECT

1 Lavatórios

APLICAÇÃO:

De posar / Murais

CARACTERÍSTICAS:

Gama composta por 4 modelos:
(ver página 089)



Bidé e sanita suspensos POP com torneira NOA para bidé

2 Sanita Compacta

MEDIDAS:

640 x 365 x 785mm

CARACTERÍSTICAS:

Descarga à parede ou ao chão



Sanita compacta, bidé simples POP e lavatório 55 POP com torneiras NOA

3 Sanita Simples

MEDIDAS:

545 / 510 x 350 x 395mm

CARACTERÍSTICAS:

Descarga à parede ou ao chão



4 Bidé Simples

MEDIDAS:

525 x 350 x 395mm



+ POP

TIPOLOGIAS:

Compacta / Simples / Suspensa

CORES:

Branco

CARACTERÍSTICAS:

Tampos de sanita disponíveis em: PP ou termodur com ou sem queda amortecida

Lavatórios 60 e 55 compatíveis com coluna e meia coluna POP

POP

COMPACTA
SIMPLES
SUSPENSA



Sanita compacta com tampo em termotur e bidé simples POP com torneira NOA



Sanita e bidé simples POP com torneira SILK para bidé

5 Sanita Suspensa

MEDIDAS:
530 x 350 x 400mm



6 Bidé Suspenso

MEDIDAS:
530 x 350 x 400mm





Sanita compacta com tampo em cor wengué e bidé GRÉCIA com torneira GRÉCIA



Lavatórios GRÉCIA 70, sanita e bidé GRÉCIA com torneiras GRÉCIA. Banheira QUEEN com torneira BALANCE de pé alto

GRÉCIA

COMPACTA

1 Lavatórios

APLICAÇÃO:

Murais ou de encastre

MEDIDAS:

70: 730 x 610 x 335mm

65: 645 x 565 x 310mm

56: 575 x 480 x 235mm (de encastre)

CARACTERÍSTICAS:

70 e 65 compatíveis com coluna GRÉCIA



2 Sanita Compacta

MEDIDAS:

730 x 495 x 795mm

CARACTERÍSTICAS:

Descarga à parede ou ao chão



3 Bidé Simples

MEDIDAS:

630 x 405 x 390mm



Lavatórios GRÉCIA 70 aplicados com coluna e torneiras para lavatório GRÉCIA

+ GRÉCIA

TIPOLOGIAS:

Compacta

CORES:

Branco / Pergamon (sob consulta)

CARACTERÍSTICAS:

Tampos de sanita disponíveis em:

Contraplacado marítimo lacado (branco / cerejeira / wengué)

1 Lavatórios

APLICAÇÃO:

Murais

MEDIDAS:

66: 665 x 525 x 225mm

60: 605 x 490 x 225mm

CARACTERÍSTICAS:

Permitem aplicação com:
coluna REGINA



Lavatório REGINA 66 aplicado com coluna

2 Sanita Compacta

MEDIDAS:

690 x 375 x 805mm

CARACTERÍSTICAS:

Descarga à parede ou ao chão



3 Bidé Simples

MEDIDAS:

565 x 385 x 425mm



Tampo de sanita em cor cerejeira



Tampo de sanita em cor wengué

+ REGINA

TIPOLOGIAS:

Compacta

CORES: Branco / Pergamon (sob consulta)

CARACTERÍSTICAS:

Tampos de sanita disponíveis em:

ABS, termotur ou contraplacado marítimo lacado (branco / cerejeira / wengué)

REGINA

COMPACTA



Sanita compacta e bidé simples REGINA



Sanita e bidé suspensos MUNIQUE com torneira UNIC e porta-rolos CONNECT



Lavatório MUNIQUE 55 aplicado com meia coluna e torneira UNIC para lavatório

+ MUNIQUE

TIPOLOGIAS:

Compacta / Simples / Suspensa

CORES: Branco / Pergamon (sob consulta)

CARACTERÍSTICAS:

Tampos de sanita disponíveis em: PP, termotur - com ou sem queda amortecida (convencional ou SLIM) - ou MDF lacado
Lavatórios compatíveis com coluna e meia coluna MUNIQUE

(*excepção: lavatório 45 e lava-mãos*)

1 Sanita Compacta

MEDIDAS:

680 x 380 x 785mm

CARACTERÍSTICAS:

Descarga à parede ou ao chão



2 Sanita Simples

MEDIDAS:

460 x 365 x 390mm /

505 x 350 x 390mm

CARACTERÍSTICAS:

Descarga à parede /

Descarga ao chão



3 Bidé Simples

MEDIDAS:

545 x 360 x 390mm



4 Sanita Suspensa

MEDIDAS:

540 x 365 x 410mm



5 Bidé Suspenso

MEDIDAS:

540 x 370 x 415mm



MUNIQUE

COMPACTA
SIMPLES
SUSPENSA

6 Lavatórios

APLICAÇÃO:

Murais

MEDIDAS:

60: 600 x 470 x 215mm

55: 560 x 435 x 205mm

45: 465 x 360 x 185mm

35: 350 x 225 x 150mm

CARACTERÍSTICAS:

Lavatórios 60 e 55 compatíveis com:
coluna e meia coluna MUNIQUE



Bidé simples e sanita compacta MUNIQUE com torneira UNIC para bidé e porta-rolô perpendicular CONNECT Round

INFANTIL

SIMPLES BTW



Sanita simples BTW INFANTIL com aro rosa com lavatórios NEXO 56 de encastre e torneira FLOW para lavatório



Sanitas simples BTW INFANTIL com aros e tampos em rosa, amarelo, azul e branco com lavatórios NEXO 56 de encastre

+ INFANTIL

TIPOLOGIAS:

Simplex BTW

MEDIDAS:

415 x 265 x 335mm

CORES:

Branco

CARACTERÍSTICAS:

Com descarga dual

Aro ou aro e tampo de sanita disponíveis em: Branco, Amarelo, Rosa e Azul



1 Lavatório

APLICAÇÃO:

Mural

MEDIDAS:

640 x 550 x 170mm



2 Sanita Compacta

MEDIDAS:

690 x 425 x 885mm

CARACTERÍSTICAS:

Descarga dual 6/3L

Tampo disponível em termodur



MOBIL

COMPACTA



Lavatório MOBIL 65 com suporte basculante aplicado



Lavatório MOBIL 65 com suporte basculante, barras fixas de 3 apoios e sanita compacta MOBIL com barras basculantes

ACESSÓRIOS

MOBILIDADE CONDICIONADA

1 BARRA Fixa

MEDIDAS: 380 x 100 x 380mm

CARACTERÍSTICAS:

Angular a 90°

Tubo em inox



2 BARRA Fixa

MEDIDAS: 800 x 100 x 380mm

CARACTERÍSTICAS:

Angular a 135°

Tubo em inox



3 BARRA Fixa

MEDIDAS: 380 x 100 x 630mm

CARACTERÍSTICAS:

Angular a 90°

Tubo em inox



4 BARRA Fixa

MEDIDAS:

375 / 495 / 635 x 70 x 100mm

CARACTERÍSTICAS:

Tubo em inox



5 BARRA Fixa

MEDIDAS: 750 x 210 x 870mm

CARACTERÍSTICAS:

Fixação ao chão

Para apoio de sanita

Tubo em inox



6 BARRA Fixa

MEDIDAS: 800 x 290 x 275mm

CARACTERÍSTICAS:

Para apoio de sanita

Tubo em inox



7 BARRA Basculante

MEDIDAS: 800 x 100 x 310mm

CARACTERÍSTICAS:

Para apoio de sanita

Tubo em inox



8 BARRA Basculante

MEDIDAS: 800 x 100 x 310mm

CARACTERÍSTICAS:

Com porta-rolos

Para apoio de sanita

Tubo em inox



9 BARRA Fixa

MEDIDAS: 600 x 275 x 240mm

CARACTERÍSTICAS:

Para apoio de lavatório

Tubo em inox



10 BARRA Basculante

MEDIDAS: 800 x 100 x 310mm

CARACTERÍSTICAS:

Basculante e curva

Para apoio de sanita

Tubo em inox



11 SUPORTE Lavatório

MEDIDAS: 640 x 600 x 400mm

CARACTERÍSTICAS:

Basculante e hidráulico

Branco (pintado) ou em inox



12 SUPORTE Lavatório

MEDIDAS: 640 x 375mm

CARACTERÍSTICAS:

Pré-regulável

Em inox



13 BANCO Rebatível

MEDIDAS: 465 x 525 x 310mm

CARACTERÍSTICAS:

Para apoio de duche

Em inox



14 ESPELHO Basculante

MEDIDAS: 600 x 800 x 145mm

CARACTERÍSTICAS:

Com pega

Em inox



ACESSÓRIOS

MONTAGEM E DESCARGA



+ CONJUNTOS Montagem

APLICAÇÃO:

Para paredes ligeiras

CARACTERÍSTICAS:

Estrutura em aço termolacado

Kits de fixação incluídos

1 CONJUNTO Compact

SUPORTE: sanitas suspensas

CARACTERÍSTICAS:

Profundidade reduzida e cisterna de dupla descarga com isolamento incluída



2 CONJUNTO Standard

SUPORTE: sanitas suspensas

CARACTERÍSTICAS:

Cisterna de dupla descarga com isolamento incluída



3 CONJUNTO Auto-portante

SUPORTE: sanitas suspensas

CARACTERÍSTICAS:

Ligações e cisterna de dupla descarga com isolamento incluídas



4 CONJUNTO Bidé

SUPORTE: bidés suspensos



5 CONJUNTO Lavatório

SUPORTE: lavatórios murais



6 CONJUNTO Urinol

SUPORTE: urinóis suspensos



+ CONJUNTOS De encastre

APLICAÇÃO:

Para paredes de alvenaria

CARACTERÍSTICAS:

Estrutura em aço galvanizado
Kits de fixação incluídos

1 CONJUNTO Compact

SUPORTE: [sanitas suspensas](#)

CARACTERÍSTICAS:

Profundidade reduzida e cisterna de dupla descarga com isolamento incluída



2 CONJUNTO Standard

SUPORTE: [sanitas suspensas](#)

CARACTERÍSTICAS:

Cisterna de dupla descarga com isolamento incluída



3 CONJUNTO LCN

SUPORTE: [sanitas suspensas](#)

CARACTERÍSTICAS:

Cisterna de dupla descarga com isolamento incluída



4 CONJUNTO Bidé

SUPORTE: [bidés suspensos](#)

CARACTERÍSTICAS:

Profundidade regulável e ligações de rede e esgoto incluídas



5 CISTERNA Compact

SUPORTE: [sanitas simples](#) / [simples BTW](#)

CARACTERÍSTICAS:

Profundidade reduzida e cisterna de dupla descarga com isolamento incluída



6 CISTERNA Standard

SUPORTE: [sanitas simples](#) / [simples BTW](#)

CARACTERÍSTICAS:

Cisterna de dupla descarga com isolamento incluída



+ ACESSÓRIOS Placas de comando

APLICAÇÃO:

De encastre

1 PLACAS Arc

CARACTERÍSTICAS:

Com dupla descarga
Em [cinza mate](#), [cromado](#)
[brilho](#) e [branco](#)



2 PLACAS Dot

CARACTERÍSTICAS:

Com dupla descarga
Em [cinza mate](#), [cromado](#)
[brilho](#) e [branco](#)



3 PLACAS Plan

CARACTERÍSTICAS:

Com dupla descarga
Em [cinza mate](#), [cromado](#)
[brilho](#) e [branco](#)



4 PLACA Plan

CARACTERÍSTICAS:

Com descarga única
Anti-vandalismo
Em [inox](#)



5 PLACAS LCN

CARACTERÍSTICAS:

Com dupla descarga
Em [cinza mate](#), [cromado](#)
[brilho](#) e [branco](#)



MODELOS E INFORMAÇÃO

SÉRIES DE BANHO / TIPOLOGIA E TECNOLOGIA

POUPANÇA DE ÁGUA

Os nossos tanques de sanita são equipados com pulsadores de dupla descarga, permitindo o controlo da quantidade de água necessária para a limpeza da sanita. Esta poderá ser feita em modos de 3/6L ou 3/4,5L, a última equipando os modelos de cisternas mais recentes.



BE YOU compacta BTW	006
CORAL compacta BTW	010
GLAM compacta BTW	012
NEXO compacta BTW	014



TIPOLOGIAS SANITÁRIAS

SIMPLES



A cisterna não necessita apoiar na sanita para esta funcionar.

POP	018
MUNIQUE	024

SIMPLES BTW



A cisterna não necessita apoiar na sanita para esta funcionar. É fixa no exterior ou interior da parede. A parte traseira da sanita encosta totalmente à parede.

BE YOU	006
CORAL	010
NEXO	014
POP ART	016
INFANTIL	026

COMPACTO



A sanita apoia no chão. A cisterna apoia na parte superior e traseira da sanita, acoplada através de fixação.

BE YOU	006
NEXO	014
POP	018
GRÉCIA	020
REGINA	022
MUNIQUE	024
MOBIL	028

COMPACTO BTW



A sanita apoia no chão. A cisterna apoia na parte superior e traseira da sanita, acoplada através de fixação. A parte traseira da sanita e da cisterna encostam totalmente à parede.

BE YOU	006
CORAL	010
GLAM	012
NEXO	014
POP ART	016

SUSPENSO



A sanita não apoia no chão. É fixa à parede através de conjuntos de montagem específicos para diferentes tipos de paredes. A cisterna não necessita apoiar na sanita para funcionar.

BE YOU	006
CORAL	010
GLAM	012
NEXO	014
POP ART	016
POP	018
MUNIQUE	024

QUEDA AMORTECIDA

Com o propósito de proporcionar maior segurança e acrescido conforto, comercializamos tampos equipados com mecanismo de queda amortecida (*soft close*). Disponíveis nas linhas mais recentes, existem em versões específicas para sanitas e bidês. As dobradiças especiais que os equipam permitem uma queda progressiva do tampo, dando maior durabilidade ao equipamento assim como maior segurança dos seus utilizadores.



BE YOU	006
CORAL	010
GLAM	012
NEXO	014
POP ART	016
POP	018
MUNIQUE	024



PROFUNDIDADES DE INSTALAÇÃO

SIMPLES



505 a 545mm

SIMPLES BTW



415 a 560mm

SUSPENSO



525 a 555mm

COMPACTO

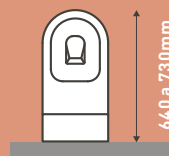

640 a 730mm

COMPACTO BTW

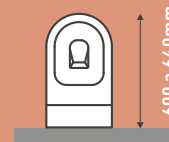

600 a 640mm

TIPOS DE SAÍDAS DE ESGOTO

DESCARGA DUAL

A sanita é equipada com descarga técnica, o que permite ajustar o sifão para que a descarga se faça na direção do solo - saída vertical - ou da parede - saída horizontal.



BE YOU	006
CORAL	010
GLAM	012
NEXO	014
POP ART	016
INFANTIL	026
MOBIL	028

DESCARGA À PAREDE

A sanita permite descarga na direção da parede - saída horizontal.



POP	018
GRÉCIA	020
REGINA	022
MUNIQUE	024

DESCARGA AO CHÃO

A sanita permite descarga na direção do chão - saída vertical.



POP	018
GRÉCIA	020
REGINA	022
MUNIQUE	024

MODELOS E APLICAÇÕES

SÉRIES DE BANHO / GUIA RÁPIDO

	BE YOU Pág. 006	CORAL Pág. 010	GLAM Pág. 012	NEXO Pág. 014	POP ART Pág. 016
SANITA Simples					
SANITA Simples BTW	•	•		•	•
SANITA Compacta	•			•	
SANITA Compacta BTW	•	•	•	•	•
SANITA Suspensa	•	•	•	•	•
TAMPO DE SANITA Termodur, simples	•	•	•	•	•
TAMPO DE SANITA Termodur, queda amortecida	•	•	•	•	•
TAMPO DE SANITA ABS					
TAMPO DE SANITA PP					
TAMPO DE SANITA MDF Lacado					
TAMPO DE SANITA Contraplacado marítimo				•	
BIDÉ Simples				•	
BIDÉ Simples BTW	•	•	•	•	•
BIDÉ Suspensa	•	•	•	•	•
TAMPO DE BIDÉ Termodur			•	•	
LAVATÓRIO De Pousar	•	•	•		•
LAVATÓRIO Mural	•	•		•	•
LAVATÓRIO De Encastre	•		•	•	
LAVATÓRIO Sobre móvel			•		
LAVA-MÃOS Mural	•			•	•
MEIA COLUNA Para lavatório	•			•	•
COLUNA Para lavatório		•		•	•

	POP Pág. 018	GRÉCIA Pág. 020	REGINA Pág. 022	MUNIQUE Pág. 024	INFANTIL Pág. 026	MOBIL Pág. 028
SANITA Simples	•			•		
SANITA Simples BTW					•	
SANITA Compacta	•	•	•	•		•
SANITA Compacta BTW						
SANITA Suspensa	•			•		
TAMPO DE SANITA Termodur, simples	•		•	•		•
TAMPO DE SANITA Termodur, queda amortecida	•			•		
TAMPO DE SANITA ABS			•			
TAMPO DE SANITA PP	•			•		
TAMPO DE SANITA MDF Lacado				•		
TAMPO DE SANITA Contraplacado marítimo		•	•		•	
BIDÉ Simples	•	•	•	•		
BIDÉ Simples BTW						
BIDÉ Suspensa	•			•		
TAMPO DE BIDÉ Termodur			•			
LAVATÓRIO De Pousar	•					
LAVATÓRIO Mural	•	•	•	•		•
LAVATÓRIO De Encastre		•				
LAVATÓRIO Sobre móvel						
LAVA-MÃOS Mural	•			•	•	
MEIA COLUNA Para lavatório	•			•		
COLUNA Para lavatório	•	•	•	•		

MODELOS E MEDIDAS

SÉRIES DE BANHO / GUIA RÁPIDO E DESENHOS TÉCNICOS

BE YOU



SANITA compacta BTW

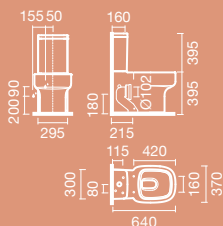

SANITA compacta

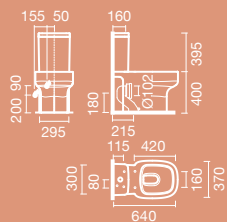

SANITA simples BTW

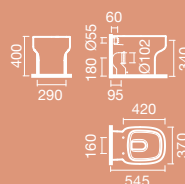

Sanita suspensa

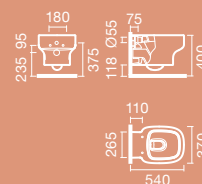

CORAL

Página 010

GLAM

SANITA compacta BTW

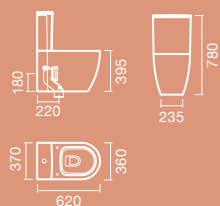

SANITA simples BTW

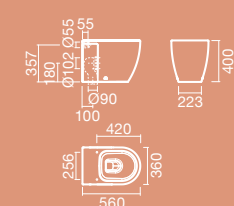

SANITA suspensa

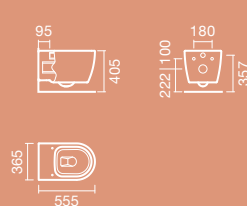

LAVATÓRIOS

Gama com 2 modelos.
Desenhos técnicos nas páginas 98



NEXO

SANITA compacta

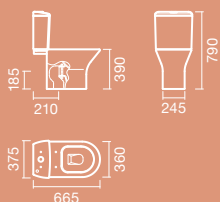

SANITA short BTW

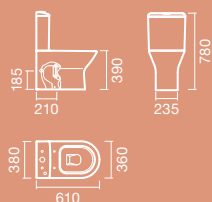

SANITA simples BTW

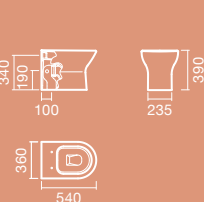

SANITA suspensa

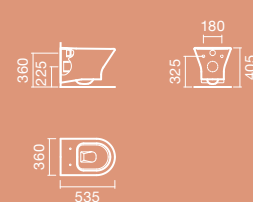

POP ART

SANITA compacta BTW

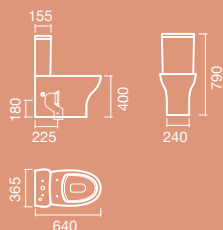

SANITA simples BTW

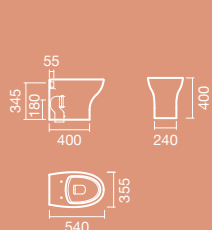

SANITA suspensa

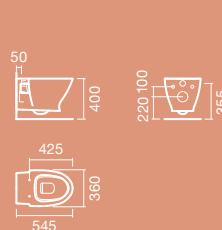

BIDÉ BTW

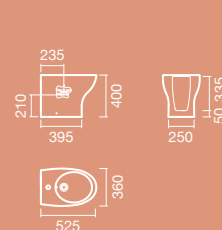

BIDÉ compacto BTW

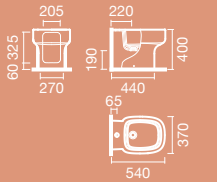

BIDÉ suspenso

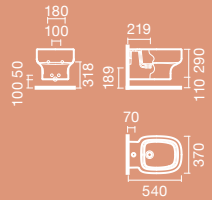

BIDÉ BTW

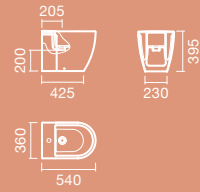

BIDÉ suspenso

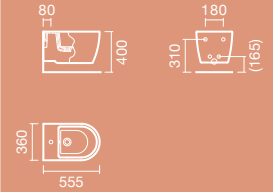

SANITA compacta BTW

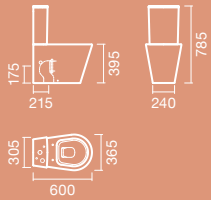

SANITA suspensa

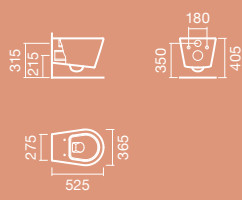

BIDÉ BTW

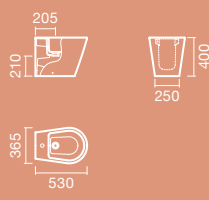

BIDÉ suspenso

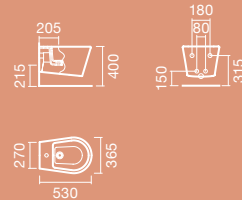

Lavatórios

Gama com 2 modelos.
Desenhos técnicos nas páginas 97 e 101

BIDÉ BTW

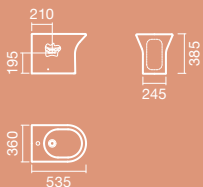

BIDÉ simples

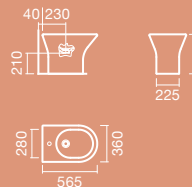

BIDÉ suspenso

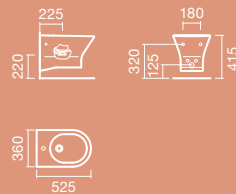

LAVATÓRIOS

Gama com 7 modelos.

BIDÉ suspenso

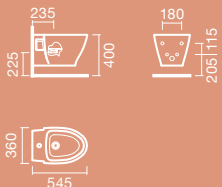

LAVATÓRIOS

Gama com 3 modelos.
Desenhos técnicos nas páginas 98 e 99



SANITA simples BTW

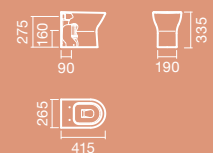

MODELOS E MEDIDAS

SÉRIES DE BANHO / GUIA RÁPIDO E DESENHOS TÉCNICOS

REGINA



SANITA compacta D/C

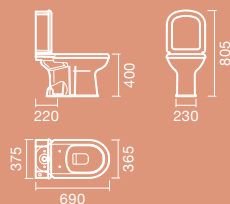

SANITA compacta D/P

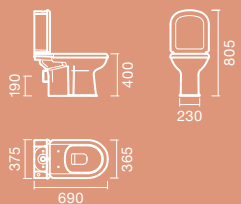

BIDÉ simples

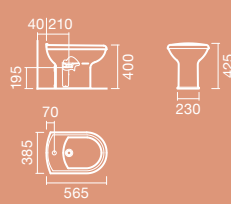

LAVATÓRIO 66 e 60

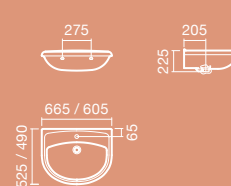

POP



SANITA compacta D/C

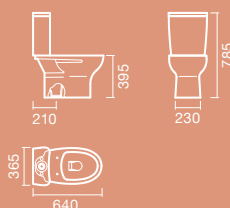

SANITA compacta D/P

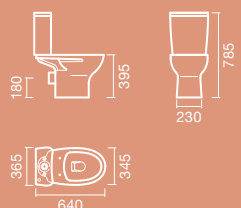

SANITA simples D/C

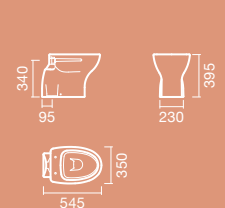

SANITA simples D/P

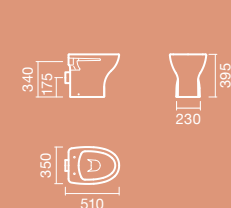

GRÉCIA



SANITA compacta D/C

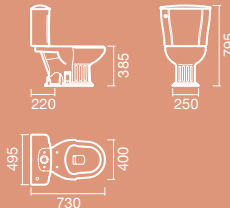

SANITA compacta D/P

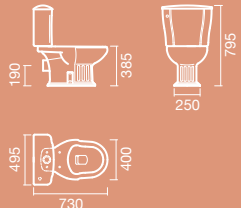

BIDÉ simples

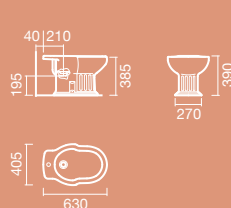

LAVATÓRIO 70

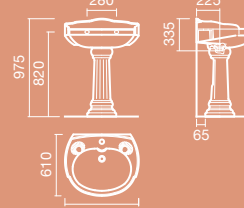

MUNIQUE



SANITA compacta D/C

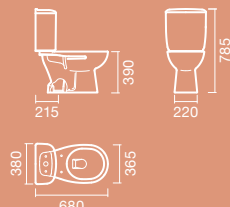

SANITA compacta D/P

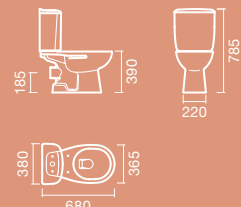

SANITA simples D/C

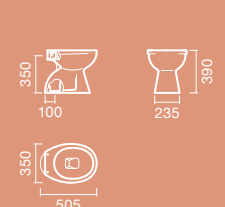

SANITA simples D/P

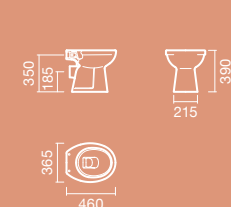

SANITA suspensa

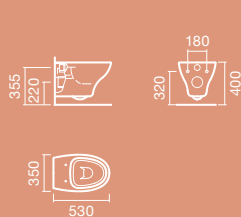

BIDÉ simples

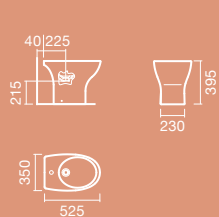

BIDÉ suspenso

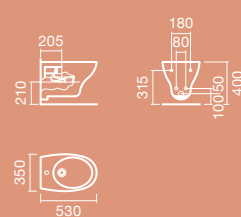

LAVATÓRIOS

Gama com 7 modelos.
Desenhos técnicos nas páginas 98 e 99

MOBIL

LAVATÓRIO 65

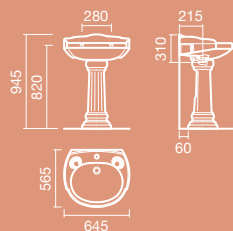

LAVATÓRIO encastre

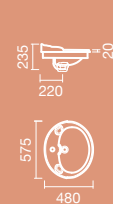

SANITA compacta

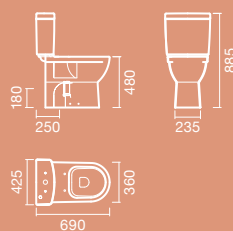

LAVATÓRIO 65

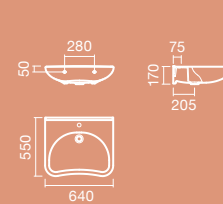

SANITA suspensa

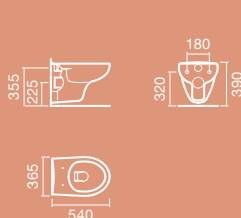

BIDÉ simples

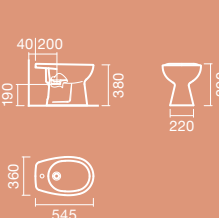

BIDÉ suspenso

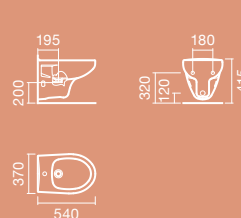

LAVATÓRIO 60 e 55

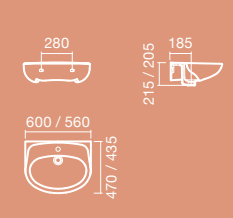

LAVATÓRIO 45 e 35

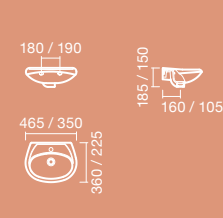

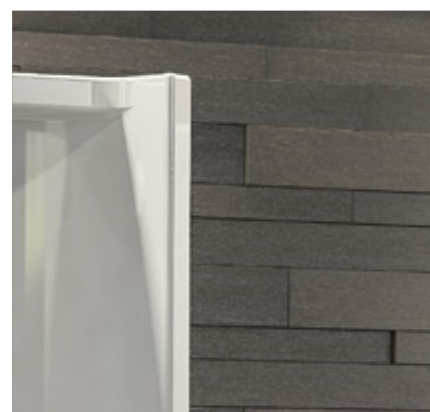
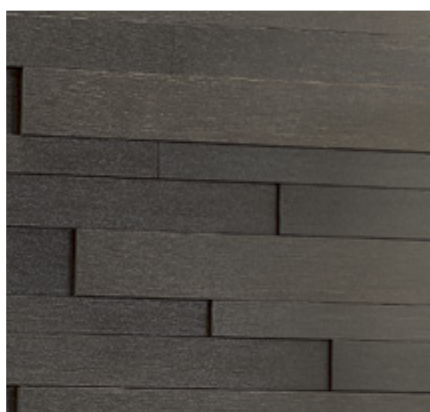
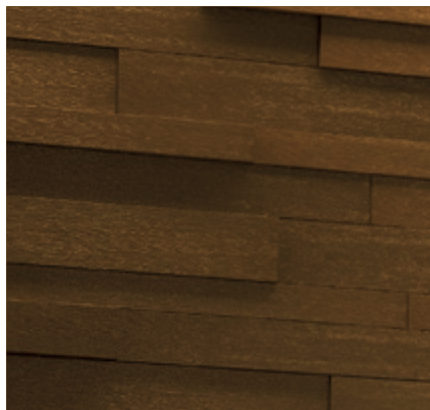

URINÓIS

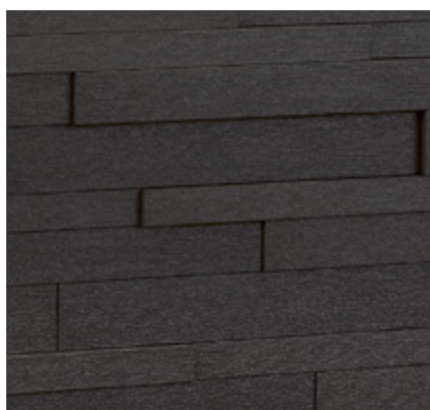

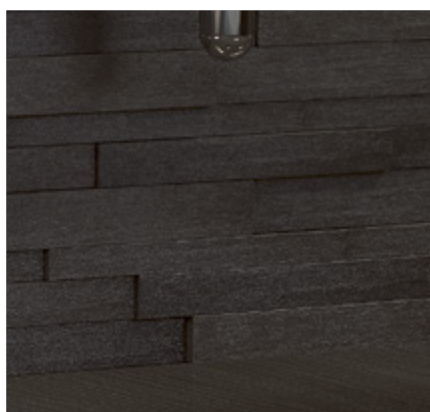
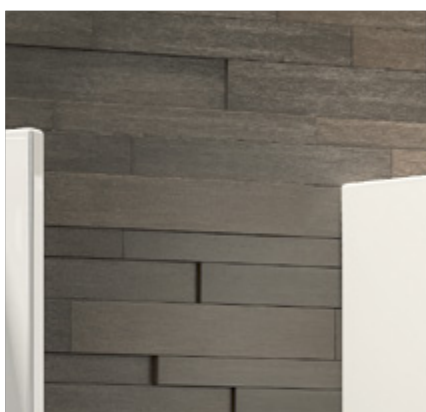
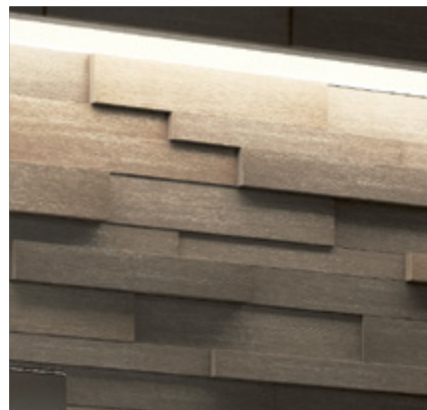
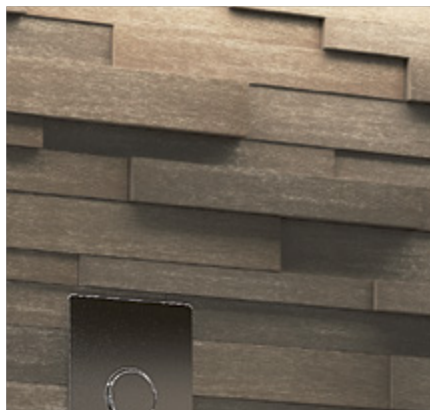

PERFORMANCE

Os nossos urinóis adequam-se a diferentes tipologias de aplicação, o que lhes confere uma flexibilidade extra na altura da instalação. As volumetrias distintas e os desenhos dos diferentes modelos permitem-lhe mais possibilidades na hora de escolher.

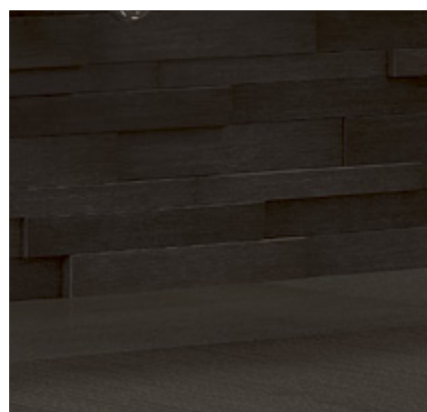

CAPRI

3 MODELOS

Urinol CAPRI com entrada de água horizontal



1 CAPRI

MEDIDAS:

315 x 345 x 545mm

CARACTERÍSTICAS:

Entrada de água vertical e saída horizontal

Sifão, emboque e kit de fixação incluídos



2 CAPRI

MEDIDAS:

315 x 345 x 545mm

CARACTERÍSTICAS:

Entrada e saída de água horizontais

Sifão, emboque, ligador e kit de fixação incluídos



3 CAPRI

MEDIDAS:

315 x 345 x 545mm

CARACTERÍSTICAS:

Com sensor eletrônico (*anti-vandalismo*)

Tranformador 24V aplicável (não incluído)

Sifão e kit de fixação incluídos



LARGE

2 MODELOS

1 LARGE

MEDIDAS:

460 x 355 x 525mm

CARACTERÍSTICAS:

Entrada de água vertical
Espalhador, válvula de esgoto,
sifão e kit de fixação incluídos



2 LARGE

MEDIDAS:

460 x 355 x 525mm

CARACTERÍSTICAS:

Entrada de água horizontal
Espalhador, válvula de esgoto,
sifão e kit de fixação incluídos



3 LARGE Sensor

CARACTERÍSTICAS:

Kit com sensor eletrônico de 230V ou 24V
Sensor eletrônico oculto (*anti-vandalismo*)
Transformador 24V aplicável (não incluído)
Kit de fixação incluído



Urinol LARGE aplicado com fluxómetro interno e sifão



Urinóis PIK aplicados com fluxómetros internos

PIK

2 MODELOS

1 PIK

MEDIDAS:

325 x 265 x 480mm

CARACTERÍSTICAS:

Entrada de água vertical

Emboque e kit de fixação incluído

2 PIK

MEDIDAS:

325 x 265 x 480mm

CARACTERÍSTICAS:

Entrada de água horizontal

Emboque, ligador e kit de fixação incluído

MINI

1 MODELO

+ MINI

MEDIDAS:

345 x 265 x 440mm

CARACTERÍSTICAS:

Emboque e kit de fixação incluído



Urinóis MINI



Urinóis MAR e separadores para urinóis +1

MAR

1 MODELO

1 MAR

MEDIDAS:

315 x 295 x 515mm

CARACTERÍSTICAS:

Entrada e saída de água horizontais

Sifão, emboque, ligador e kit de fixação incluídos



+ SEPARADOR +1

MEDIDAS:

440 x 90 x 850mm

CARACTERÍSTICAS:

Separador de urinóis

Kit de fixação incluído

MODELOS E MEDIDAS

URINÓIS / GUIA RÁPIDO E DESENHOS TÉCNICOS

CAPRI

Página 042



Entrada de água VERTICAL

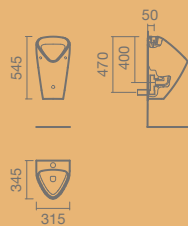

Entrada de água HORIZONTAL

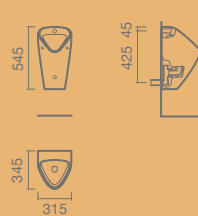

Sensor ELETRÔNICO

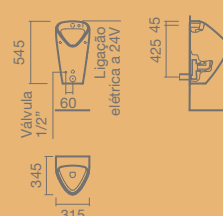

LARGE

Página 043



Entrada de água VERTICAL

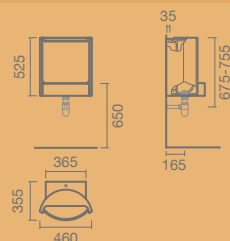

Entrada de água HORIZONTAL

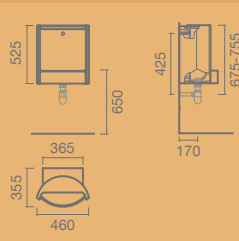

PIK

Página 044



Entrada de água VERTICAL

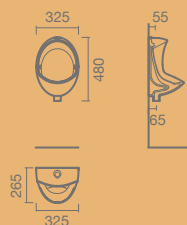

Entrada de água HORIZONTAL

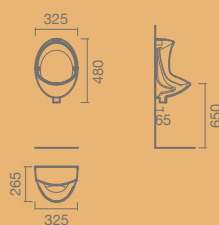

MINI

Página 044

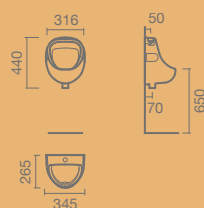



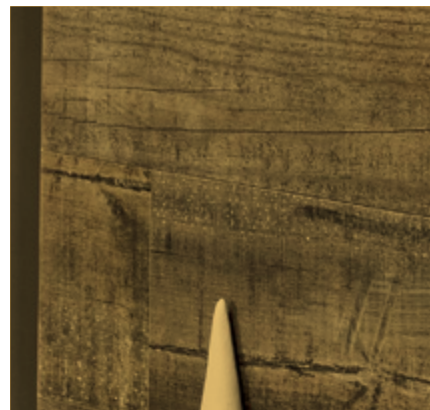
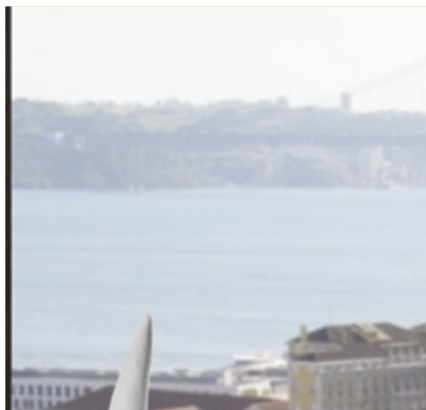

LAVATÓRIOS

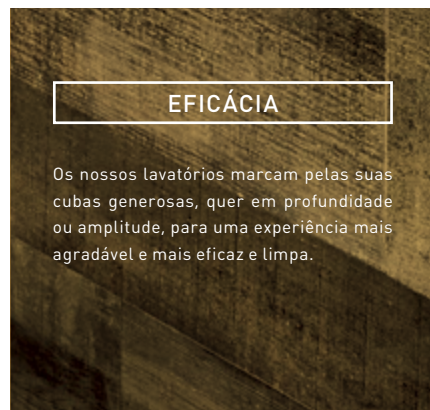

EFICÁCIA

Os nossos lavatórios marcam pelas suas cubas generosas, quer em profundidade ou amplitude, para uma experiência mais agradável e mais eficaz e limpa.

DIVERSIDADE

Com modelos de encastre e semi-encastre, de posar, murais (com coluna e meia coluna) e modelos de aplicação sobre móvel, com ou sem furação para torneira, os lavatórios Sanitana oferecem uma ampla variedade de estilos, formatos e dimensões, numa vasta gama de soluções.

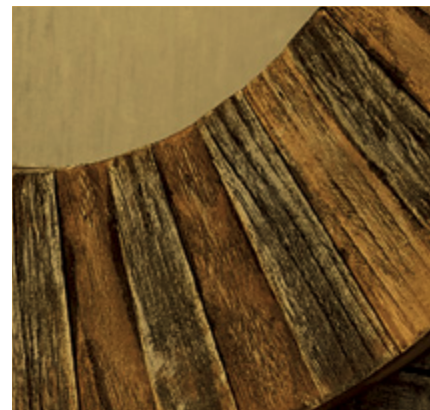
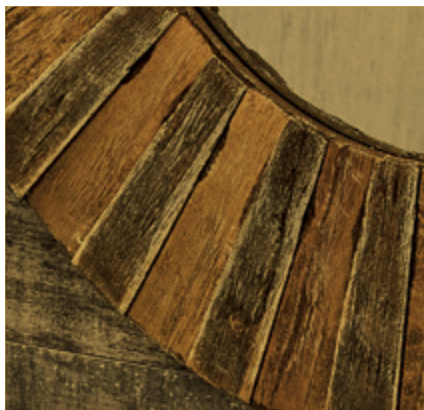

ESTILO

Jogue com formas contemporâneas. Descubra uma vasta gama de lavatórios e escolha um estilo, formato e medida que se adaptem ao seu gosto pessoal. Desde referentes mais regulares a soluções de espírito mais modernista, irá encontrar o que procura.

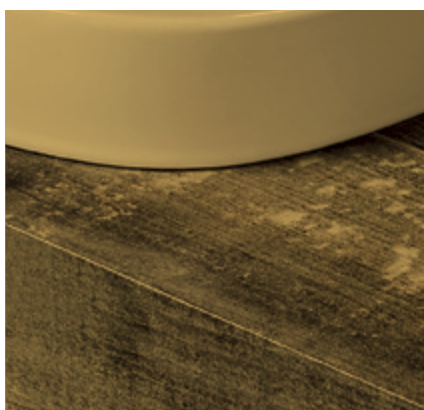
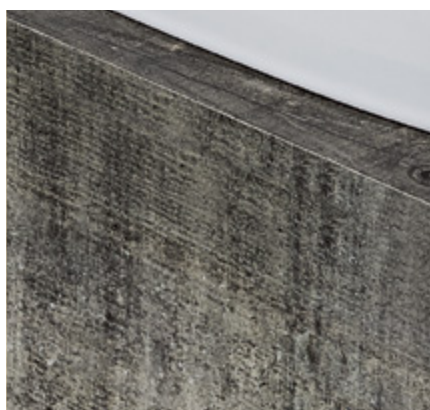

SMOOTH

DE ENCASTRE
MURAI



Lavatório SMOOTH 120 mural com cuba à esquerda e toalheiro, torneira BALANCE para lavatório e espelho SIRIUS



O QUE É O SOLID SURFACE?

O *solid surface* é um material compósito constituído por resina de poliéster híbrida e cargas de alumina. Acetinado ao toque e com um acabamento mate, lembra a sensação da pedra polida. É a combinação perfeita entre beleza e desempenho, com características exclusivas que o fazem capaz de responder ao mais exigente dos critérios. Para que tenha a tranquilidade de saber que escolheu um material duradouro, investimos anos de pesquisa na formulação do nosso *solid surface*. Desde a primeira molécula até ao molde, todo o processo de produção é feito na Sanitana, onde é acompanhado por colaboradores altamente especializados.

OS 4 MITOS DO SOLID SURFACE

É DIFÍCIL DE LIMPAR?



Não, é **simples**: basta usar sabão ou detergente de limpeza e uma esponja de cozinha comum e esfregar a superfície com um movimento circular. Com **qualidades sanitárias atestadas**, a superfície compacta e não-porosa do nosso *solid surface* não permite que as bactérias ou fungos cresçam ou se espalhem, tendo sido pensado para uma **manutenção sem preocupações**.

RISCA FACILMENTE?



O *solid surface* é um material **extremamente durável**. No entanto, como qualquer material de uso diário, o seu desgaste normal pode implicar alguns riscos. No caso do *solid surface*, contudo, a **maioria das reparações são rápidas e simples**. Para além disso, de forma a minimizar a percepção de qualquer desgaste os SMOOTH oferecem um acabamento mate que reduz a sua visibilidade de pequenas imperfeições.

FICA COM MANCHAS?



Não, o *solid surface* é **resistente a manchas**. É um material homogéneo, com uma notável estabilidade quando exposto a raios ultravioleta (UV) ou a iluminação artificial, mantendo-se inalterado. Graças à sua superfície não-porosa **qualquer sujidade**, mesmo a mais entranhada, **pode ser removida**, facilitando a manutenção do seu espaço de banho.

É FACILMENTE INFLAMÁVEL?



O *solid surface* é uma superfície sólida não-tóxica altamente **resistente ao calor e ao fogo**. É também capaz de resistir a ambientes extremos, tais como em zonas junto ao mar, áreas expostas a humidade ou temperaturas abaixo de zero. No entanto, como com todos os materiais, é importante minimizar a exposição directa de calor para proteger a sua superfície.

1 SMOOTH

APLICAÇÃO: De encastre / Sobre móvel

MEDIDAS: 1002 / 902 x 458 x 147mm

CORES: Branco

CARACTERÍSTICAS:

Em *solid surface*

Sem furação para torneira

SMOOTH 100 compatível com:

móveis DIXIE 100 (Pág. 154) e TAHOE 100 (Pág. 152)

SMOOTH 90 compatível com:

móvel TAHOE 90 (Pág. 152)



2 SMOOTH Duplo

APLICAÇÃO: Mural

MEDIDAS: 1600 x 530 x 150mm

CORES: Branco

CARACTERÍSTICAS:

Em *solid surface*

Com ou sem furações para torneiras

Com ou sem toaheiros

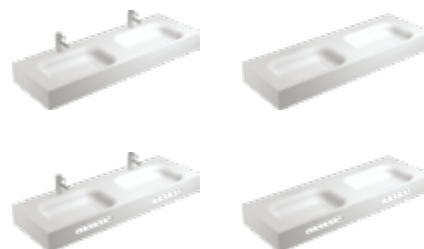

3 SMOOTH

APLICAÇÃO: Mural

MEDIDAS:

1400 / 1200 / 1000 / 900 / 800 x 530 x 150mm

CORES: Branco

CARACTERÍSTICAS:

Em *solid surface*

Cuba: central / à esquerda / à direita

Com ou sem furação para torneira

Com ou sem toaheiro



Pormenor do lavatório SMOOTH 120 mural com toalheiro



Lavatório SMOOTH 120 mural com cuba à esquerda e toalheiro, torneira BALANCE para lavatório e espelho SIRIUS



Detalhe da aba do lavatório de encastre assimétrico BE YOU 60



Lavatórios de encastre BE YOU 50



N
O
V
I
D
A
D
E

+ BE YOU

APLICAÇÃO:

- Mural
- De posar
- De Encastre

CORES: Branco

CARACTERÍSTICAS:

Com ou sem furação para torneira



BE YOU

MURAIIS
DE POUSAR
DE ENCASTRE
LAVA-MÃOS



Lavatórios de pousar BE YOU 55 com torneiras UNIC para lavatório



1 Lavatórios De Encastre

MEDIDAS:

60 com furo: 630 x 400 x 120mm (assimétrico)

60 com furo: 600 x 460 x 120mm

50 com furo: 500 x 460 x 120mm

60 sem furo: 600 x 350 x 120mm

50 sem furo: 500 x 350 x 120mm



Lavatório de encastre BE YOU 50 com torneira BLOC para lavatório

2 Lavatórios De pousar

MEDIDAS:

60: 600 x 430 x 165mm

55: 550 x 430 x 165mm

40: 400 x 430 x 165mm



3 Lavatórios Murais

MEDIDAS:

60: 600 x 430 x 165mm

55: 550 x 430 x 165mm

40: 400 x 430 x 165mm

40 canto: 420 x 460 x 170mm



Lavatório de encastre BE YOU 60 com torneira BALANCE de parede



Lavatórios murais SHAPE com torneiras UNIC para lavatório



Vista lateral do lavatório SHAPE

SHAPE

MURAL

+ SHAPE

APLICAÇÃO: Mural
MEDIDAS: 515 x 480 x 600mm
CORES: Branco
CARACTERÍSTICAS:
 Com furação para torneira

ARENA

DE POUSAR



Lavatório de pousar ARENA 38 em aplicação sobre móvel YANKARI 80

ARENA Rectangular

APLICAÇÃO: De pousar

MEDIDAS:
700 x 380 x 128mm

CORES: Branco

CARACTERÍSTICAS:
Sem furação para torneira

ARENA Quadrado

APLICAÇÃO: De pousar

MEDIDAS:
380 x 380 x 128mm

CORES: Branco

CARACTERÍSTICAS:
Sem furação para torneira



Lavatório de pousar ARENA 70 em aplicação sobre bancada com torneira UNIC de cano alto para lavatório



TRIK

DE POUSAR

TRIK

APLICAÇÃO: De pousar

MEDIDAS: 730 x 440 x 170mm

CORES: Branco

CARACTERÍSTICAS:

Sem furação para torneira

Com embelezador de válvula em cerâmica



Lavatório TRIK em aplicação sobre bancada com torneira SILK de cano alto para lavatório



Lavatórios ORBIT em aplicação sobre bancada

ORBIT

DE POUSAR

 **ORBIT**

APLICAÇÃO: De posar

MEDIDAS: 440 x 500 x 160mm

CORES: Branco

CARACTERÍSTICAS:

Sem furação para torneira

Com embelezador de válvula em cerâmica



Lavatórios ORBIT em aplicação sobre bancada com torneiras UNIC de cano alto para lavatório



Lavatório RAMP em aplicação sobre bancada com torneira SILK de cano alto para lavatório

RAMP

DE POUSAR

+ RAMP

APLICAÇÃO: De posar
MEDIDAS: 620 x 430 x 180mm
CORES: Branco
CARACTERÍSTICAS:
 Sem furação para torneira



Lavatório RAMP em aplicação sobre bancada

INDY

DE ENCASTRE



1 INDY

APLICAÇÃO: Encastre por cima

MEDIDAS:

900 x 400 x 144mm

650 x 350 x 144mm

CORES: Branco

CARACTERÍSTICAS:

Sem furação para torneira

Com embelezador de válvula em cerâmica



Lavatório INDY 65 com torneira SILK de cano alto para lavatório

DROP

MURAL

+ DROP

APLICAÇÃO: Mural

MEDIDAS: 700 x 350 x 154mm

CORES: Branco

CARACTERÍSTICAS:

Com furação para torneira



Lavatório mural DROP com torneira SILK para lavatório e espelho ASTERION

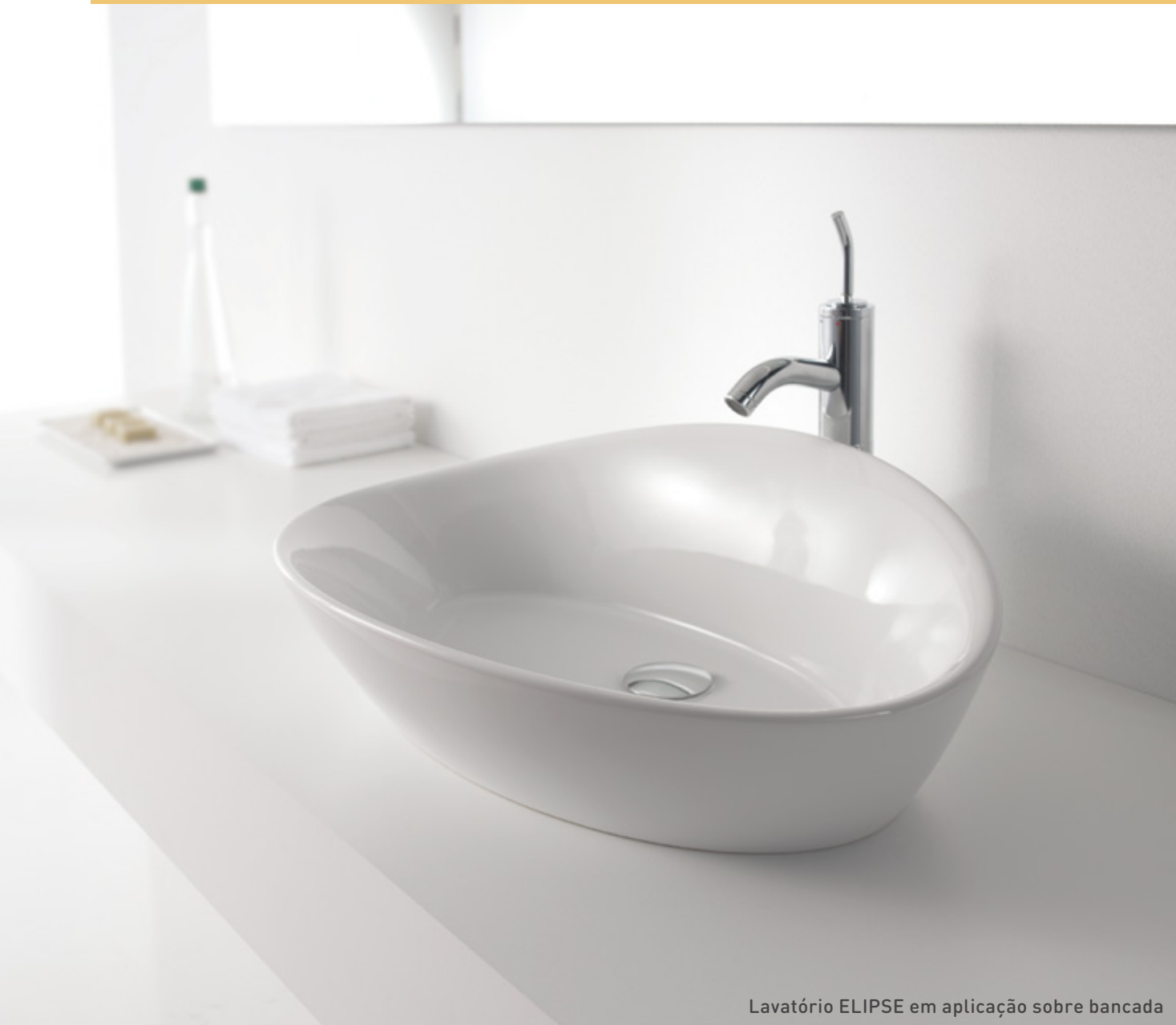

Lavatório ELIPSE em aplicação sobre bancada

ELIPSE

DE POUSAR

ELIPSE

APLICAÇÃO: De posar

MEDIDAS: 630 x 430 x 190mm

CORES: Branco

CARACTERÍSTICAS:

Sem furação para torneira

CUBIC

DE POUSAR, MURALS E SOBRE MÓVEIS



Lavatório CUBIC 80



Lavatório CUBIC 50 em aplicação sobre bancada

1 CUBIC

APLICAÇÃO: De posar, mural e sobre móvel

MEDIDAS:

795 x 345 x 145mm

595 x 340 x 145mm

500 x 345 x 150mm

CORES: Branco

CARACTERÍSTICAS:

Com furação para torneira à direita

Compatíveis com móveis CUBIC (página 156)



AIDA

DE POUSAR, MURAI E SOBRE MÓVEIS
DE ENCASTRE



Lavatório AIDA 100 em aplicação sobre bancada com torneiras BLOC

1 AIDA Duplo

APLICAÇÃO: De pousar / Mural

MEDIDAS: 1000 x 500 x 132mm

CORES: Branco

CARACTERÍSTICAS:

Com duas cubas e furações para torneiras

Compatível com móveis WEZA 100 (pág. 148)



2 AIDA

APLICAÇÃO: De pousar / Mural / Sobre móvel

MEDIDAS:

800 x 500 x 132mm

650 x 500 x 132mm

CORES: Branco

CARACTERÍSTICAS:

Com furação para torneira

Compatíveis com móveis WEZA (pág. 148)



3 AIDA De encastre

APLICAÇÃO: Encastre por baixo

MEDIDAS: 545 x 430 x 157mm

CORES: Branco / Pergamon (sob consulta)

CARACTERÍSTICAS:

Sem furação para torneira





LAVATÓRIOS

Lavatório STADIO 60 em aplicação de encastre em bancada com torneira UNIC de cano alto (25cm) para lavatório



Lavatório STADIO 33 com torneira UNIC de cano alto

STADIO

DE ENCASTRE

+ STADIO

APLICAÇÃO: Encastre por cima

MEDIDAS:

600 x 330 x 135mm

330 x 330 x 135mm

CORES: Branco

CARACTERÍSTICAS:

Sem furação para torneira



Lavatórios ALBUS 45 de semi-encastre

ALBUS

DE POUSAR
DE SEMI-ENCASTRE

1 ALBUS De pousar

APLICAÇÃO: De pousar

MEDIDAS:

605 x 455 x 130mm

455 x 455 x 130mm

CORES: Branco

CARACTERÍSTICAS:

Com ou sem furação para torneira

Com ou sem furo ladrão



N
O
V
I
D
A
D
E

Lavatório ALBUS 45 sem furação para torneira com torneira BALANCE de pé alto para lavatório



Lavatórios ALBUS 60 sem furação para torneira em aplicação sobre bancada com torneiras BALANCE de cano alto

1 ALBUS De semi-encastre

APLICAÇÃO: De semi-encastre

MEDIDAS: 450 x 475 x 150mm

CORES: Branco

CARACTERÍSTICAS:

Com furação para torneira

Com furo ladrão



Lavatório ALBUS de semi-encastre com torneira BALANCE

UP

DE POUSAR



Lavatório UP quadrado com torneira BALANCE de parede para lavatório

1 UP Rectangular

APLICAÇÃO: De pousar
MEDIDAS: 600 x 400 x 120mm
CORES: Branco
CARACTERÍSTICAS:
 Reversível
 Com furação para torneira



2 UP Rectangular

APLICAÇÃO: De pousar
MEDIDAS: 600 x 400 x 120mm
CORES: Branco
CARACTERÍSTICAS:
 Com furação para torneira



3 UP Rectangular

APLICAÇÃO: De pousar
MEDIDAS: 593 x 395 x 119mm
CORES: Branco
CARACTERÍSTICAS:
 Sem furação para torneira



4 UP Oval

APLICAÇÃO: De pousar
MEDIDAS: 593 x 395 x 119mm
CORES: Branco
CARACTERÍSTICAS:
 Sem furação para torneira



5 UP Quadrado

APLICAÇÃO: De pousar
MEDIDAS: 395 x 395 x 119mm
CORES: Branco
CARACTERÍSTICAS:
 Sem furação para torneira



6 UP Circular

APLICAÇÃO: De pousar
MEDIDAS: 395 x 395 x 119mm
CORES: Branco
CARACTERÍSTICAS:
 Sem furação para torneira



GLAM

DE POUSAR
DE ENCASTRE / SOBRE MÓVEL



Lavatório GLAM 70 em aplicação de encastre em bancada

LAVATÓRIOS



Lavatório GLAM 55 em aplicação sobre bancada com torneira BALANCE

1 GLAM 55

APLICAÇÃO: De pousar
MEDIDAS: 560 x 420 x 165mm
CORES: Branco
CARACTERÍSTICAS:
Com furação para torneira



2 GLAM 70

APLICAÇÃO: Encastre por cima e sobre móvel
MEDIDAS: 700 x 465 x 155mm
CORES: Branco
CARACTERÍSTICAS:
Extraplano
Com furação para torneira
Compatível com móvel GLAM 70 (pág. 158)





Lavatório WAVE

WAVE

DE POUSAR / MURAI S

 **WAVE**

APLICAÇÃO: De pousar / Mural

MEDIDAS: 500 x 450 x 145mm

CORES: Branco

CARACTERÍSTICAS:

Com furação para torneira



Lavatório WAVE em aplicação sobre bancada com torneira SILK para lavatório



Lavatório CITY em aplicação sobre bancada

CITY

DE POUSAR / MURALS
SEMI-ENCASTRE

1 CITY

APLICAÇÃO: De pousar / Mural

MEDIDAS: 480 x 480 x 180mm

CORES: Branco

CARACTERÍSTICAS:

Com furação para torneira



2 CITY

APLICAÇÃO: Semi-encastre

MEDIDAS: 480 x 480 x 180mm

CORES: Branco

CARACTERÍSTICAS:

Com furação para torneira





Lavatório CASUAL 80 em aplicação mural com torneira BLOC para lavatório

CASUAL

DE POUSAR, MURAI E SOBRE MÓVEIS

CASUAL

APLICAÇÃO: De pousar, mural e sobre móvel

MEDIDAS:

800 x 475 x 140mm

600 x 475 x 140mm

CORES: Branco

CARACTERÍSTICAS:

Com furação para torneira

Compatível com móveis CASUAL (pág. 160)

SMILE

SOBRE MÓVEIS

1 SMILE

APLICAÇÃO: Sobre móvel

MEDIDAS:

1210 x 460 x 185mm (duplo)

1010 x 460 x 185mm

910 x 460 x 185mm

810 x 455 x 185mm

610 x 460 x 185mm

CORES: Branco

CARACTERÍSTICAS:

Com furações para torneira

Compatível com:

Móveis TAHOE (pág. 152),

DIXIE (pág. 154) e COOL (pág. 167)



Lavatório SMILE 90 sobre móvel COOL 90 em cor nogueira

LUNA

DE POUSAR

+ LUNA

APLICAÇÃO: De pousar

MEDIDAS: 610 x 460 x 140mm

CORES: Branco

CARACTERÍSTICAS:

Com furação para torneira



Lavatório LUNA em aplicação sobre bancada



Lavatório SOFT com furação para torneira em aplicação mural

SOFT

DE POUSAR

DE POUSAR / MURAL

1 SOFT

APLICAÇÃO: De pousar / Mural

MEDIDAS: 575 x 455 x 165mm

CORES: Branco

CARACTERÍSTICAS:

Com furação para torneira

2 SOFT

APLICAÇÃO: De pousar

MEDIDAS: 575 x 450 x 140mm

CORES: Branco

CARACTERÍSTICAS:

Sem furação para torneira



Lavatório ÓVALO sem furação para torneira em aplicação de encastre em bancada com torneira BALANCE



Lavatório ÓVALO em aplicação sobre bancada

ÓVALO

DE POUSAR E DE ENCASTRE

+ ÓVALO

APLICAÇÃO:

De posar, de encastre e semi-encastre

MEDIDAS: 635 x 390 x 140mm

CORES: Branco

CARACTERÍSTICAS:

Sem furação para torneira

CIRCLE

DE POUSAR E DE ENCASTRE

CIRCLE

APLICAÇÃO:

De posar, de encastre e semi-encastre

MEDIDAS: 395 x 395 x 140mm

CORES: Branco

CARACTERÍSTICAS:

Sem furação para torneira



Lavatório CIRCLE em aplicação sobre bancada com torneira BALANCE de cano alto para lavatório

URBAN

DE POUSAR

+ URBAN

APLICAÇÃO: De pousar

MEDIDAS:

450 x 450 x 165mm (com furação)

450 x 450 x 140mm (sem furação)

CORES: Branco

CARACTERÍSTICAS:

Com ou sem furação para torneira



Lavatório URBAN sem furação com torneira BALANCE de parede

LAVATÓRIOS

CUP

DE POUSAR



Lavatório CUP em aplicação sobre bancada

+ CUP

APLICAÇÃO: De pousar

MEDIDAS: 410 x 350 x 145mm

CORES: Branco

CARACTERÍSTICAS:

Sem furação para torneira

NEXO

MURAIIS
DE ENCASTRE
LAVA-MÃOS



Lava-mãos NEXO 50 de canto



Lavatório NEXO de encastre por cima

1 NEXO

APLICAÇÃO: Mural

MEDIDAS:

600 x 475 x 185mm

550 x 440 x 190mm

CORES: Branco

CARACTERÍSTICAS:

Com furação para torneira

Coluna e meia coluna disponíveis



2 NEXO Encastre

APLICAÇÃO:

Encastre por cima

Encastre por cima ou por baixo

MEDIDAS:

560 x 470 x 185mm (com furação)

560 x 400 x 190mm (sem furação)

CORES: Branco

CARACTERÍSTICAS:

Com e sem furação para torneira



3 NEXO Lava-mãos

APLICAÇÃO: Mural

MEDIDAS:

500 x 545 x 170mm (de canto)

450 x 360 x 170mm

415 x 285 x 150mm

CORES: Branco

CARACTERÍSTICAS:

Com furação para torneira





Lavatório NEXO 60 com meia coluna, torneira FLOW para lavatório, toalheiro CONNECT ROUND 300 e espelho MAYARA

POP ART

DE POUSAR / MURALS

LAVA-MÃOS



Lavatório POP ART 62 em aplicação sobre bancada com torneira BALANCE para lavatório

1 POP ART

APLICAÇÃO: De pousar / Mural

MEDIDAS:

620 x 485 x 185mm

570 x 485 x 185mm

505 x 440 x 185mm

CORES: Branco

CARACTERÍSTICAS:

Com furação para torneira

Coluna (apenas POP ART 62 e 57)

e meia coluna disponíveis



2 POP ART Lava-mãos

APLICAÇÃO: De pousar / Mural

MEDIDAS: 400 x 350 x 170mm

CORES: Branco

CARACTERÍSTICAS:

Com furação para torneira



MIXMI

DE POUSAR / MURAIIS

+ MIXMI

APLICAÇÃO: De posar / Mural

MEDIDAS:

650 x 430 x 168mm

570 x 430 x 168mm

CORES: Branco

CARACTERÍSTICAS:

Com furação para torneira

Compatíveis com coluna NEXO



Lavatórios MIXMI 57 em aplicação sobre bancada com torneiras UNIC para lavatório



Lava-mãos ONDA em aplicação mural com torneira SELEKT para lavatório

ONDA

LAVA - MÃOS

+ ONDA Canto

APLICAÇÃO: Mural

MEDIDAS: 400 x 275 x 160mm

CORES: Branco

CARACTERÍSTICAS:

Com furação para torneira

Lateral vitrificada

ISLA

LAVA - MÃOS

+ ISLA Canto

APLICAÇÃO: Mural

MEDIDAS: 395 x 505 x 190mm

CORES: Branco

CARACTERÍSTICAS:

Com furação para torneira



Lava-mãos ISLA em aplicação mural com torneira SELEKT

POP

DE POUSAR / MURAIIS
LAVA - MÃOS

1 POP

APLICAÇÃO: De pousar / Mural

MEDIDAS:

600 x 450 x 175mm

555 x 460 x 175mm

CORES: Branco

CARACTERÍSTICAS:

Com furação para torneira

Coluna e meia coluna disponíveis



2 POP Lava-mãos 45

APLICAÇÃO: De pousar / Mural

MEDIDAS: 450 x 375 x 175mm

CORES: Branco

CARACTERÍSTICAS:

Com furação para torneira



3 POP Lava-mãos 36

APLICAÇÃO: De pousar / Mural

MEDIDAS: 360 x 320 x 170mm

CORES: Branco

CARACTERÍSTICAS:

Com furação para torneira



Lavatórios POP 55 com torneiras FLOW para lavatório

PETIT

LAVA - MÃOS

+ PETIT

APLICAÇÃO: Mural / Sobre móvel

MEDIDAS: 400 x 217 x 103mm

CORES: Branco

CARACTERÍSTICAS:

Com furação para torneira (ESQ / DIR)

Compatíveis com móveis PETIT (página 166)



Lava-mãos PETIT direito em aplicação mural



Lava-mãos MUNIQUE em aplicação mural com torneira UNIC

MUNIQUE

LAVA - MÃOS

+ MUNIQUE

APLICAÇÃO: Mural

MEDIDAS: 350 x 225 x 150mm

CORES: Branco

CARACTERÍSTICAS:

Com furação para torneira à direita

GRÉCIA

DE ENCASTRE

+ GRÉCIA

APLICAÇÃO: Encastre por cima
MEDIDAS: 575 x 480 x 235mm
CORES: Branco / Pergamon (sob consulta)
CARACTERÍSTICAS:
 Com furação para torneira



Lavatório GRÉCIA em aplicação de encastre com torneira COSMO

LAVATÓRIOS

JARA

DE ENCASTRE

+ JARA

APLICAÇÃO: Encastre por cima
MEDIDAS: 395 x 395 x 190mm
CORES: Branco
CARACTERÍSTICAS:
 Sem furação para torneira
 Vidrado por cima e por baixo



Lavatório JARA em aplicação de encastre em bancada



Lavatórios ANADIA em aplicação de encastre por baixo com torneiras FLOW para lavatório

ANADIA

DE ENCASTRE

+ ANADIA

APLICAÇÃO: Encastre por baixo

MEDIDAS: 535 x 400 x 220mm

CORES: Branco / Pergamon (sob consulta)

CARACTERÍSTICAS:

Sem furação para torneira



Lavatório ANADIA em aplicação de encastre por baixo



Lavatório LUSO em aplicação de encastre por cima com torneira NOA para lavatório



Lavatório LUSO em aplicação de encastre por cima

LUSO

DE ENCASTRE

+ LUSO

APLICAÇÃO: Encastre por cima

MEDIDAS: 565 x 480 x 215mm

CORES: Branco / Pergamon (sob consulta)

CARACTERÍSTICAS:

Com furação para torneira

MODELOS E APLICAÇÕES

LAVATÓRIOS E LAVA-MÃOS / GUIA RÁPIDO E DESENHOS TÉCNICOS



MURAI Solid surface

 <p>SMOOTH 1600 x 530 x 150mm</p> <p>Página 050</p>  <p>Versão sem furação disponível</p>	 <p>SMOOTH 1600 x 530 x 150mm</p> <p>Página 050</p>  <p>Versão sem furação disponível</p>	 <p>SMOOTH 1400 x 530 x 150mm</p> <p>Página 050</p>  <p>Versão sem furação disponível</p>	 <p>SMOOTH 1400 x 530 x 150mm</p> <p>Página 050</p>  <p>Versão sem furação disponível</p>	 <p>SMOOTH 1400 x 530 x 150mm</p> <p>Página 050</p>  <p>Versão sem furação disponível</p>
 <p>SMOOTH 1400 x 530 x 150mm</p> <p>Página 050</p>  <p>Versão sem furação disponível</p>	 <p>SMOOTH 1400 x 530 x 150mm</p> <p>Página 050</p>  <p>Versão sem furação disponível</p>	 <p>SMOOTH 1400 x 530 x 150mm</p> <p>Página 050</p>  <p>Versão sem furação disponível</p>	 <p>SMOOTH 1200 x 530 x 150mm</p> <p>Página 050</p>  <p>Versão sem furação disponível</p>	 <p>SMOOTH 1200 x 530 x 150mm</p> <p>Página 050</p>  <p>Versão sem furação disponível</p>
 <p>SMOOTH 1200 x 530 x 150mm</p> <p>Página 050</p>  <p>Versão sem furação disponível</p>	 <p>SMOOTH 1200 x 530 x 150mm</p> <p>Página 050</p>  <p>Versão sem furação disponível</p>	 <p>SMOOTH 1200 x 530 x 150mm</p> <p>Página 050</p>  <p>Versão sem furação disponível</p>	 <p>SMOOTH 1200 x 530 x 150mm</p> <p>Página 050</p>  <p>Versão sem furação disponível</p>	 <p>SMOOTH 1000 x 530 x 150mm</p> <p>Página 050</p>  <p>Versão sem furação disponível</p>

MURAI Solid surface

 <p>SMOOTH 1000 x 530 x 150mm</p> <p>Página 050</p>  <p>Versão sem furação disponível</p>	 <p>SMOOTH 1000 x 530 x 150mm</p> <p>Página 050</p>  <p>Versão sem furação disponível</p>	 <p>SMOOTH 1000 x 530 x 150mm</p> <p>Página 050</p>  <p>Versão sem furação disponível</p>	 <p>SMOOTH 1000 x 530 x 150mm</p> <p>Página 050</p>  <p>Versão sem furação disponível</p>	 <p>SMOOTH 1000 x 530 x 150mm</p> <p>Página 050</p>  <p>Versão sem furação disponível</p>
 <p>SMOOTH 900 x 530 x 150mm</p> <p>Página 050</p>  <p>Versão sem furação disponível</p>	 <p>SMOOTH 900 x 530 x 150mm</p> <p>Página 050</p>  <p>Versão sem furação disponível</p>	 <p>SMOOTH 800 x 530 x 150mm</p> <p>Página 050</p>  <p>Versão sem furação disponível</p>	 <p>SMOOTH 800 x 530 x 150mm</p> <p>Página 050</p>  <p>Versão sem furação disponível</p>	

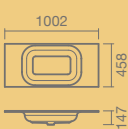
DE ENCASTRE Solid surface

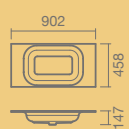
 <p>SMOOTH 1002 x 458 x 147mm</p> <p>Página 050</p>  <p>Versão sem furação disponível</p>	 <p>SMOOTH 902 x 458 x 147mm</p> <p>Página 050</p>  <p>Versão sem furação disponível</p>
--	---

MODELOS E APLICAÇÕES

LAVATÓRIOS E LAVA-MÃOS / GUIA RÁPIDO E DESENHOS TÉCNICOS

DE POUSAR Cerâmicos

 <p>BE YOU 60 600 x 430 x 165mm</p> <p>Página 054</p> 	 <p>BE YOU 55 550 x 430 x 165mm</p> <p>Página 054</p> 	 <p>BE YOU 40 400 x 430 x 165mm</p> <p>Página 054</p> 	 <p>ALBUS 60 605 x 455 x 130mm</p> <p>Página 072</p>  <p>Versões sem furações disponíveis</p>	 <p>ALBUS 45 455 x 455 x 130mm</p> <p>Página 072</p>  <p>Versões sem furações disponíveis</p>
 <p>ARENA 700 x 380 x 128mm</p> <p>Página 060</p> 	 <p>ARENA 380 x 380 x 128mm</p> <p>Página 060</p> 	 <p>TRIK 730 x 440 x 170mm</p> <p>Página 062</p> 	 <p>ORBIT 440 x 500 x 160mm</p> <p>Página 064</p> 	 <p>RAMP 620 x 430 x 180mm</p> <p>Página 065</p> 
 <p>ELIPSE 630 x 430 x 190mm</p> <p>Página 068</p> 	 <p>SOFT 575 x 450 x 140mm</p> <p>Página 080</p> 	 <p>UP 600 x 400 x 120mm</p> <p>Página 074</p> 	 <p>UP 600 x 400 x 120mm</p> <p>Página 074</p> 	 <p>UP 593 x 395 x 119mm</p> <p>Página 074</p> 

 <p>UP 593 x 395 x 119mm Página 074</p> 	 <p>UP 395 x 395 x 119mm Página 074</p> 	 <p>UP 395 x 395 x 119mm Página 074</p> 	 <p>URBAN 450 x 450 x 140mm Página 083</p> 	 <p>URBAN 450 x 450 x 165mm Página 083</p> 
 <p>OVALO 635 x 390 x 140mm Página 081</p> 	 <p>CIRCLE 395 x 395 x 140mm Página 082</p> 	 <p>LUNA 610 x 460 x 140mm Página 080</p> 	 <p>GLAM 560 x 420 x 165mm Página 075</p> 	 <p>CUP 410 x 350 x 145mm Página 083</p> 











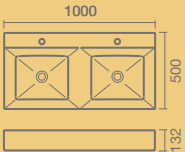

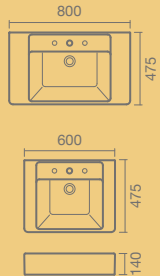

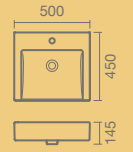

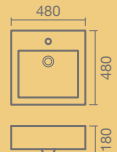

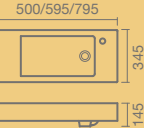
MURAI Cerâmicos

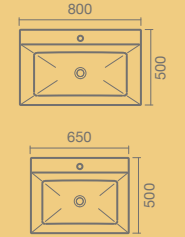
 <p>BE YOU 60 600 x 430 x 165mm Página 054</p> 	 <p>BE YOU 55 550 x 430 x 165mm Página 054</p> 	 <p>BE YOU 40 400 x 430 x 165mm Página 054</p> 	 <p>SHAPE 515 x 480 x 600mm Página 059</p> 	 <p>DROP 700 x 350 x 154mm Página 067</p> 
--	--	--	--	---

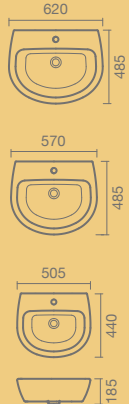
MODELOS E APLICAÇÕES

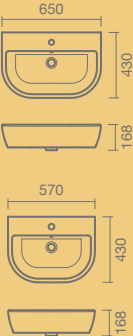
LAVATÓRIOS E LAVA-MÃOS / GUIA RÁPIDO E DESENHOS TÉCNICOS

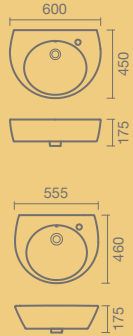
DE POUSAR/MURAI S Cerâmicos

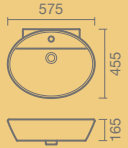
 <p>AIDA Duplo 1000 x 500 x 132mm</p> <p>Página 070</p>  <p>Permite aplicação sobre móvel</p>	 <p>CASUAL 800 x 475 x 140mm 600 x 475 x 140mm</p> <p>Página 078</p>  <p>Permite aplicação sobre móvel</p>	 <p>WAVE 500 x 450 x 145mm</p> <p>Página 076</p>  <p>Permite aplicação sobre móvel</p>	 <p>CITY 480 x 480 x 180mm</p> <p>Página 077</p>  <p>Permite aplicação sobre móvel</p>	 <p>CUBIC 795 x 345 x 145mm 595 x 340 x 145mm 500 x 345 x 150mm</p> <p>Página 069</p>  <p>Permite aplicação sobre móvel</p>
 <p>AIDA 800 x 500 x 132mm 650 x 500 x 132mm</p> <p>Página 070</p>  <p>Permite aplicação sobre móvel</p>	 <p>POP ART 620 x 485 x 185mm 570 x 485 x 185mm 505 x 440 x 185mm</p> <p>Página 086</p>  <p>Permite aplicação sobre móvel</p>	 <p>MIXMI 650 x 430 x 168mm 570 x 430 x 168mm</p> <p>Página 087</p>  <p>Permite aplicação sobre móvel</p>	 <p>POP 600 x 450 x 175mm 555 x 460 x 175mm</p> <p>Página 089</p>  <p>Permite aplicação sobre móvel</p>	 <p>SOFT 575 x 455 x 165mm</p> <p>Página 080</p>  <p>Permite aplicação sobre móvel</p>

LAVA-MÃOS Cerâmicos



BE YOU 40
420 x 460 x 170mm

Página 054



ISLA
395 x 505 x 190mm

Página 088



ONDA
400 x 275 x 160mm

Página 088

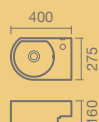

MUNIQUE
350 x 225 x 150mm

Página 090



POP 45
450 x 375 x 175mm

Página 089



POP 36
360 x 320 x 170mm

Página 089



POP ART
400 x 350 x 170mm

Página 086



PETIT Esquerdo
400 x 217 x 103mm

Página 090

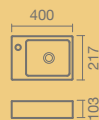

PETIT Direito
400 x 217 x 103mm

Página 090

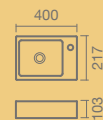

MODELOS E APLICAÇÕES

LAVATÓRIOS E LAVA-MÃOS / GUIA RÁPIDO E DESENHOS TÉCNICOS

DE ENCASTRE Cerâmicos

 <p>BE YOU 60 600 x 460 x 120mm</p> <p>Página 054</p> 	 <p>BE YOU 60 500 x 460 x 120mm</p> <p>Página 054</p> 	 <p>BE YOU 60 630 x 400 x 120mm</p> <p>Página 054</p> 	 <p>BE YOU 60 600 x 350 x 120mm</p> <p>Página 054</p> 	 <p>BE YOU 50 500 x 350 x 120mm</p> <p>Página 054</p> 
 <p>INDY 90 900 x 400 x 144mm</p> <p>Página 066</p> 	 <p>INDY 65 650 x 350 x 144mm</p> <p>Página 066</p> 	 <p>STADIO 60 600 x 330 x 135mm</p> <p>Página 071</p> 	 <p>STADIO 33 330 x 330 x 135mm</p> <p>Página 071</p> 	 <p>AIDA 545 x 430 x 157mm</p> <p>Página 070</p> 
 <p>SMILE Duplo 1210 x 460 x 185mm</p> <p>Página 079</p>  <p>Permite aplicação sobre móvel</p>	 <p>SMILE 100 1010 x 460 x 185mm</p> <p>Página 079</p>  <p>Permite aplicação sobre móvel</p>	 <p>SMILE 90 910 x 460 x 185mm</p> <p>Página 079</p>  <p>Permite aplicação sobre móvel</p>	 <p>SMILE 80 810 x 455 x 185mm</p> <p>Página 079</p>  <p>Permite aplicação sobre móvel</p>	 <p>SMILE 60 610 x 460 x 185mm</p> <p>Página 079</p>  <p>Permite aplicação sobre móvel</p>

DE ENCASTRE Cerâmicos



ALBUS

450 x 475 x 150mm

Página 072

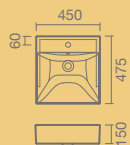

CITY

480 x 480 x 180mm

Página 077

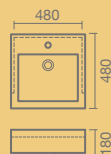

GLAM

700 x 465 x 155mm

Página 075

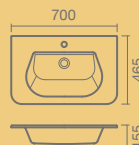

Permite aplicação sobre móvel



OVALO

635 x 390 x 140 mm

Página 081

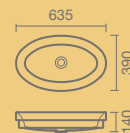

CIRCLE

395 x 395 x 140mm

Página 082



GRECIA

575 x 480 x 235mm

Página 091



JARA

395 x 395 x 190mm

Página 091



ANADIA

535 x 400 x 220mm

Página 092



LUSO

565 x 480 x 215mm

Página 093





ECOLOGIA

Porquê usar o fluxo máximo de água quando metade basta? O cartucho ecológico, através dos seus discos cerâmicos, condiciona a abertura do manípulo a 2 tempos: sensivelmente 50% de fluxo de água com meia abertura do manípulo e 100% com abertura total.

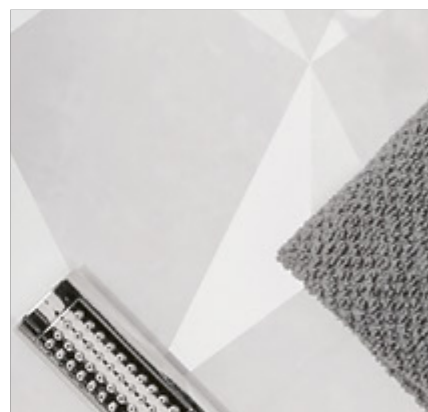
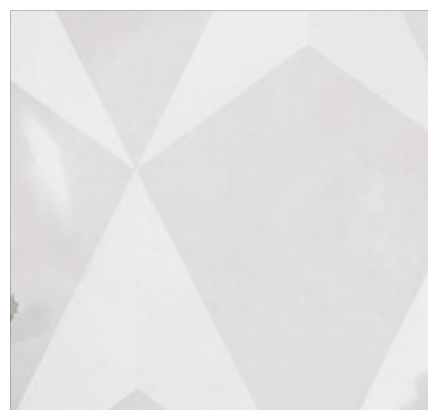

TORNEIRAS



GARANTIA 5 ANOS

Porque nos empenhamos na qualidade dos produtos que desenvolvemos, oferecemos-lhe 5 anos de garantia em toda a gama de misturadoras que comercializamos. A garantia é aplicável a partir da data de aquisição do produto.

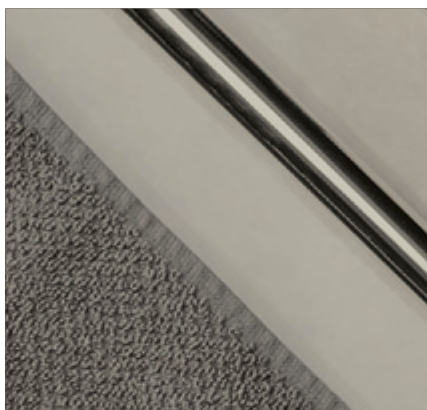
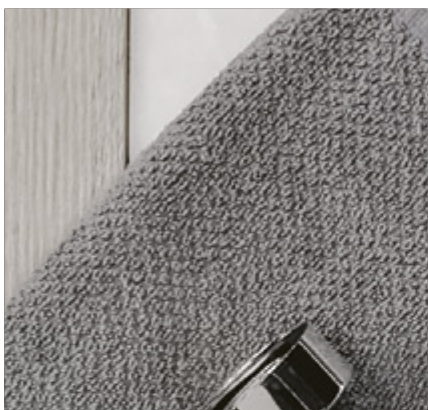

EFICÁCIA

A preocupação com a performance chega também ao controlo da temperatura de água e aos gastos energéticos. Os modelos de misturadoras termostáticas têm como propósito controlar e limitar a temperatura da água, proporcionando-lhe o conforto acrescido e seguro.

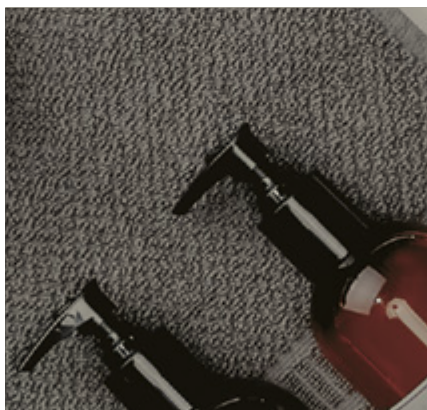

ORBIS

12 MODELOS



N
O
V
I
D
A
D
E

Torneira ORBIS de cano alto com lavatório de encastre BE YOU 50

1 ORBIS Lavatório

CARACTERÍSTICAS:
Cartucho ecológico due
Função energy smile
Perlador ecológico



2 ORBIS Lavatório

CARACTERÍSTICAS:
Cano alto
Cartucho ecológico due
Função energy smile
Perlador ecológico



3 ORBIS Lavatório

CARACTERÍSTICAS:
Bica curta ou longa (22 ou 13cm)
Cartucho ecológico due
Função energy smile
Perlador ecológico

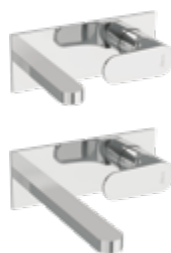

4 ORBIS Bidé

CARACTERÍSTICAS:
Cartucho ecológico due
Função energy smile
Perlador ecológico



5 ORBIS Chuveiro

CARACTERÍSTICAS:
 Cartucho cerâmico
 Espelho circular ou quadrado
 De encastre: 3 vias (1 função)

**6 ORBIS Chuveiro / Banheira**

CARACTERÍSTICAS:
 Cartucho cerâmico
 Espelho circular ou rectangular
 De encastre: 4 vias (2 funções)

**7 ORBIS Chuveiro**

CARACTERÍSTICAS:
 Cartucho cerâmico
 Chuveiro de mão, suporte e flexível
 com redutor de caudal 5l/min incluídos

**8 ORBIS Chuveiro**

CARACTERÍSTICAS:
 Cartucho cerâmico
 Chuveiro superior de grande dimensão (22cm)
 Chuveiro de mão, suporte e flexível incluídos

**9 ORBIS Banheira**

CARACTERÍSTICAS:
 Cartucho cerâmico
 Chuveiro de mão, suporte e flexível
 com redutor de caudal 5l/min incluídos

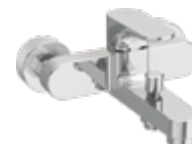

Torneira ORBIS com chuveiro superior de grande dimensão



Torneira MOON para bidé

MOON

5 MODELOS

1 MOON Lavatório

CARACTERÍSTICAS:

- Função *energy smile*
- Perlator ecológico orientável 7°
- Cartucho cerâmico ecológico *due*



2 MOON Lavatório

CARACTERÍSTICAS:

- Cano alto
- Função *energy smile*
- Perlator ecológico orientável 7°
- Cartucho cerâmico ecológico *due*



3 MOON Bidé

CARACTERÍSTICAS:

- Função *energy smile*
- Perlator ecológico orientável 7°
- Cartucho cerâmico ecológico *due*



4 MOON Chuveiro

CARACTERÍSTICAS:

- Cartucho cerâmico ecológico *due*
- Chuveiro de mão, suporte e flexível incluídos



5 MOON Banheira

CARACTERÍSTICAS:

- Perlator orientável 7°
- Cartucho cerâmico ecológico *due*
- Chuveiro de mão, suporte e flexível incluídos





Torneira MOON para lavatório

ART

7 MODELOS



Torneira ART para banheira

1 ART Lavatório

CARACTERÍSTICAS:

Cartucho cerâmico
Cascata de água aberta
Regulador de caudal ajustável



2 ART Lavatório

CARACTERÍSTICAS:

Cartucho cerâmico
Cascata de água fechada
Regulador de caudal ajustável



3 ART Lavatório

CARACTERÍSTICAS:

Cartucho cerâmico
Perlator ecológico orientável



4 ART Bidé

CARACTERÍSTICAS:

Cartucho cerâmico
Cascata de água fechada
Regulador de caudal ajustável





Torneiras ART para lavatório e bidé

5 ART Bidé**CARACTERÍSTICAS:**

Rótula orientável
 Cartucho cerâmico
 Regulador de caudal ajustável

**6 ART Chuveiro****CARACTERÍSTICAS:**

Cartucho cerâmico
 Chuveiro de mão, suporte e flexível incluídos

**7 ART Banheira****CARACTERÍSTICAS:**

Cascata de água e cartucho cerâmico
 Chuveiro de mão, suporte e flexível incluídos





Torneira BLOC para lavatório

BLOC

5 MODELOS

1 BLOC Lavatório

CARACTERÍSTICAS:
Cartucho cerâmico



2 BLOC Bidé

CARACTERÍSTICAS:
Cartucho cerâmico





Torneira BLOC para bidé

3 BLOC Chuveiro

CARACTERÍSTICAS:
 Cartucho cerâmico
 Chuveiro de mão, suporte e flexível incluídos



4 BLOC Banheira

CARACTERÍSTICAS:
 Cartucho cerâmico
 Chuveiro de mão, suporte e flexível incluídos



Torneira BLOC para banheira

5 BLOC Chuveiro

CARACTERÍSTICAS:
 Misturadora termostática
 Chuveiro superior de grande dimensão (20cm)
 Chuveiro de mão, suporte e flexível incluídos





Torneira SILK de cano alto para lavatório

SILK

30 MODELOS



Torneira SILK para bidé

1 SILK Lavatório

CARACTERÍSTICAS:

Cartucho cerâmico ecológico *due*
Com ou sem cano alto



3 SILK Lavatório

CARACTERÍSTICAS:

De encastre
Cartucho cerâmico ecológico *due*
Com bica longa ou curta (22 e 13cm)



5 SILK Banheira

CARACTERÍSTICAS:

Cartucho cerâmico ecológico *due*
Chuveiro de mão, suporte e flexível incluídos



2 SILK Bidé

CARACTERÍSTICAS:

Cartucho cerâmico ecológico *due*



4 SILK Chuveiro

CARACTERÍSTICAS:

Cartucho cerâmico ecológico *due*
Chuveiro de mão, suporte
e flexível incluídos



6 SILK Chuveiro

CARACTERÍSTICAS:

Cartucho cerâmico ou termostático
Espelho circular ou quadrado
De encastre: 3 vias (1 função)



7 SILK Chuveiro / Banheira**CARACTERÍSTICAS:**

Cartucho cerâmico ou termostático
 Espelho circular e rectangular (vertical ou horizontal)
 De encaixe: 4 vias (2 funções)

**8** SILK Chuveiro / Banheira**CARACTERÍSTICAS:**

Cartucho cerâmico ou termostático
 Espelhos circulares ou rectangular
 De encaixe: 5 vias (3 funções)

**9** SILK Chuveiro / Banheira**CARACTERÍSTICAS:**

Cartucho cerâmico ou termostático
 Espelho circular e rectangular
 (vertical ou horizontal)
 De encaixe: 6 vias (4 funções)

**10** SILK Chuveiro**CARACTERÍSTICAS:**

Chuveiro superior de grande dimensão (22,5cm)
 Cartucho cerâmico ecológico *due*
 Chuveiro de mão, suporte e flexível incluídos



Torneira SILK para lavatório



Torneira BALANCE para lavatório

1 BALANCE Lavatório

CARACTERÍSTICAS:

- Função *energy smile*
- Com perlator ecológico
- Cartucho cerâmico ecológico *due*
- Com ou sem cano alto



2 BALANCE Lavatório

CARACTERÍSTICAS:

- De encastre
- Com perlator ecológico
- Cartucho cerâmico ecológico *due*
- Com bica longa ou curta (22 e 13cm)



3 BALANCE Lavatório

CARACTERÍSTICAS:

- Com perlator ecológico
- Sensor infra-vermelhos (2 águas)



4 BALANCE Bidê

CARACTERÍSTICAS:

- Função *energy smile*
- Com perlator ecológico
- Cartucho cerâmico ecológico *due*



5 BALANCE Chuveiro

CARACTERÍSTICAS:

- Monocomando ou termostática
- Chuveiro de mão, suporte e flexível incluídos



6 BALANCE Banheira

CARACTERÍSTICAS:

- Monocomando ou termostática
- Chuveiro de mão, suporte e flexível incluídos



7 BALANCE Chuveiro

CARACTERÍSTICAS:

- Misturadora termostática
- Chuveiro de grande dimensão (20cm)
- Chuveiro de mão, suporte e flexível incluídos



8 BALANCE Banheira

CARACTERÍSTICAS:

- De pé alto
- Cartucho cerâmico ecológico *due*
- Chuveiro de mão, suporte e flexível incluídos



BALANCE

30 MODELOS



Torneira BALANCE com chuveiro superior de grande dimensão

9 BALANCE Chuveiro

CARACTERÍSTICAS:

Cartucho cerâmico ou termostático
Espelho circular ou quadrado
De encastre: 3 vias (1 função)



10 BALANCE Chuveiro / Banheira

CARACTERÍSTICAS:

Cartucho cerâmico ou termostático
Espelho circular e rectangular
(vertical ou horizontal)
De encastre: 4 vias (2 funções)



11 BALANCE Chuveiro / Banheira

CARACTERÍSTICAS:

Cartucho cerâmico ou termostático
Espelhos circulares ou rectangular
De encastre: 5 vias (3 funções)

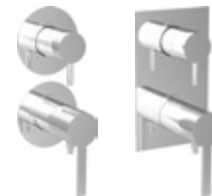

12 BALANCE Chuveiro / Banheira

CARACTERÍSTICAS:

Cartucho cerâmico ou termostático
Espelhos circulares e rectangulares
(vertical ou horizontal)
De encastre: 6 vias (4 funções)





Torneira COSMO para lavatório

COSMO

22 MODELOS

1 COSMO Lavatório

CARACTERÍSTICAS:
Função *energy smile*
Com perlador ecológico
Cartucho cerâmico ecológico *due*
Com ou sem cano alto



2 COSMO Lavatório

CARACTERÍSTICAS:
De encastre
Temporizada



3 COSMO Lavatório

CARACTERÍSTICAS:
De encastre
Com bica longa ou curta (22,5 ou 14,5cm)



4 COSMO Bidé

CARACTERÍSTICAS:
Função *energy smile*
Com perlador ecológico
Cartucho cerâmico ecológico *due*



5 COSMO Chuveiro

CARACTERÍSTICAS:
 Cartucho cerâmico
 Chuveiro de mão, suporte e flexível incluídos



6 COSMO Chuveiro

CARACTERÍSTICAS:
 De encastre
 Cartucho cerâmico



7 COSMO Chuveiro

CARACTERÍSTICAS:
 Espelho circular
 Cartucho cerâmico ou termostático
 De encastre: 3 vias (1 função)



8 COSMO Chuveiro / Banheira

CARACTERÍSTICAS:
 Espelho circular
 Cartucho cerâmico ou termostático
 De encastre: 4 vias (2 funções)



9 COSMO Chuveiro / Banheira

CARACTERÍSTICAS:
 Espelhos circulares
 Cartucho cerâmico ou termostático
 De encastre: 5 vias (3 funções)



10 COSMO Chuveiro

CARACTERÍSTICAS:
 De encastre
 Temporizadas



11 COSMO Chuveiro

CARACTERÍSTICAS:
 Misturadora termostática
 Chuveiro superior de grande dimensão (20cm)
 Chuveiro de mão, suporte e flexível incluídos



12 COSMO Banheira

CARACTERÍSTICAS:
 Cartucho cerâmico
 Chuveiro de mão, suporte e flexível incluídos

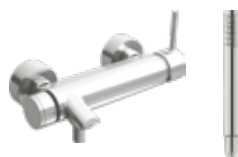

13 COSMO Banheira

CARACTERÍSTICAS:
 De encastre
 Cartucho cerâmico



Torneira COSMO com chuveiro superior

FLOW

7 MODELOS



Torneira FLOW para lavatório

1 FLOW Lavatório

CARACTERÍSTICAS:
Cartucho cerâmico

**2 FLOW** Lavatório

CARACTERÍSTICAS:
De encastre
Cartucho cerâmico

**3 FLOW** Bidé

CARACTERÍSTICAS:
Cartucho cerâmico

**4 FLOW** Chuveiro

CARACTERÍSTICAS:
Cartucho cerâmico
Chuveiro de mão, suporte
e flexível incluídos

**5 FLOW** Banheira

CARACTERÍSTICAS:
Cartucho cerâmico
Chuveiro de mão, suporte
e flexível incluídos



Torneira FLOW para bidé



Torneira FLOW para chuveiro

UNIC

40 MODELOS

1 UNIC Lavatório

CARACTERÍSTICAS:

Perlator orientável 7°
 Cartucho cerâmico ecológico *due*
 Com ou sem manípulo de acessibilidade



2 UNIC Lavatório

CARACTERÍSTICAS:

Perlator ecológico
 Temporizada
 1 ou 2 águas



3 UNIC Lavatório

CARACTERÍSTICAS:

Perlator orientável 7°
 Cartucho cerâmico ecológico *due*
 Com cano alto (30 ou 25cm)



4 UNIC Lavatório

CARACTERÍSTICAS:

Perlator ecológico
 Com cano alto: 1 ou 2 águas
 Temporizada



Torneira UNIC para lavatório

5 UNIC Lavatório

CARACTERÍSTICAS:

De encastre
 Cartucho cerâmico ecológico *due*
 Com bica longa ou curta (22 e 13cm)



6 UNIC Lavatório

CARACTERÍSTICAS:

Perlator ecológico
 Com sensor infra-vermelhos
 1 ou 2 águas



7 UNIC Bidé

CARACTERÍSTICAS:

Cartucho cerâmico ecológico *due*





Torneira UNIC com chuveiro superior de grande dimensão

12 UNIC Chuveiro

CARACTERÍSTICAS:
 Termostática
 Chuveiro superior de grande dimensão (22,5cm)
 Chuveiro de mão, suporte e flexível incluídos



TORNEIRAS

8 UNIC Chuveiro

CARACTERÍSTICAS:
 Cartucho cerâmico ou termostático
 Espelho circular ou quadrado
 De encastre: 3 vias (1 função)



9 UNIC Chuveiro / Banheira

CARACTERÍSTICAS:
 Cartucho cerâmico ou termostático
 Espelho circular, rectangular (vertical ou horizontal)
 De encastre: 4 vias (2 funções)



13 UNIC Chuveiro

CARACTERÍSTICAS:
 Cartucho cerâmico ecológico *due*
 Chuveiro de mão, suporte e flexível incluídos



10 UNIC Chuveiro / Banheira

CARACTERÍSTICAS:
 Cartucho cerâmico ou termostático
 Espelhos circulares ou rectangular
 De encastre: 5 vias (3 funções)



11 UNIC Chuveiro / Banheira

CARACTERÍSTICAS:
 Cartucho cerâmico ou termostático
 Espelhos circulares e rectangulars (vertical ou horizontal)
 De encastre: 6 vias (4 funções)



14 UNIC Banheira

CARACTERÍSTICAS:
 Cartucho cerâmico ecológico *due*
 Chuveiro de mão, suporte e flexível incluídos



SELEKT

5 MODELOS



N
O
V
I
D
A
D
E
S

1 SELEKT Lavatório

CARACTERÍSTICAS:

Cartucho cerâmico ecológico
Permite limitar consumos



2 SELEKT Lavatório

CARACTERÍSTICAS:

Cano alto
Cartucho cerâmico ecológico
Permite limitar consumos



3 SELEKT Bidé

CARACTERÍSTICAS:

Cartucho cerâmico ecológico
Permite limitar consumos



Torneira SELEKT para bidé



Torneiras SELEKT para lavatório

4 SELEKT Chuveiro

CARACTERÍSTICAS:
 Cartucho cerâmico ecológico
 Permite limitar consumos
 Chuveiro de mão, suporte
 e flexível incluídos



5 SELEKT Banheira

CARACTERÍSTICAS:
 Cartucho cerâmico
 Chuveiro de mão, suporte
 e flexível incluídos





Torneira NOA para lavatório

+ **NOA Lavatório**

CARACTERÍSTICAS:
Cartucho cerâmico ecológico *due*



+ **NOA Bidé**

CARACTERÍSTICAS:
Cartucho cerâmico ecológico *due*



Torneira NOA para bidé

NOA

6 MODELOS

+ NOA Chuveiro

CARACTERÍSTICAS:
Cartucho cerâmico ecológico *due*
Chuveiro de mão, suporte
e flexível incluídos



+ NOA Banheira

CARACTERÍSTICAS:
Cartucho cerâmico ecológico *due*
Chuveiro de mão, suporte
e flexível incluídos



TORNEIRAS



Torneira NOA para banheira

DELTA

4 MODELOS



Torneira DELTA para lavatório

+ DELTA Bidé

CARACTERÍSTICAS:
Cartucho cerâmico ecológico *due*



+ DELTA Chuveiro

CARACTERÍSTICAS:
Cartucho cerâmico ecológico *due*
Chuveiro de mão, suporte e flexível incluídos



Torneira DELTA para banheira

XS

4 MODELOS



Torneira XS para lavatório

+ XS Bidé

CARACTERÍSTICAS:
Cartucho cerâmico



+ XS Chuveiro

CARACTERÍSTICAS:
Cartucho cerâmico



+ XS Banheira

CARACTERÍSTICAS:
Cartucho cerâmico



ATLAS 40

9 MODELOS



Torneira ATLAS 40 para lavatório

1 ATLAS 40 Lavatório

CARACTERÍSTICAS:

Cartucho cerâmico ecológico *due*
Com ou sem manípulo de acessibilidade



2 ATLAS 40 Bidé

CARACTERÍSTICAS:

Cartucho cerâmico ecológico *due*
Com ou sem manípulo de acessibilidade



3 ATLAS 40 Chuveiro

CARACTERÍSTICAS:

Cartucho cerâmico ecológico *due*
Com ou sem manípulo de acessibilidade
Chuveiro de mão, suporte e flexível incluídos



4 ATLAS 40 Banheira

CARACTERÍSTICAS:

Cartucho cerâmico ecológico *due*
Chuveiro de mão, suporte e flexível incluídos



GRÉCIA

4 MODELOS



Torneira GRÉCIA para lavatório

TORNEIRAS



Torneira GRÉCIA para bidé

+ GRÉCIA Chuveiro

CARACTERÍSTICAS:

Castelos cerâmicos

Chuveiro de mão, suporte e flexível incluídos



+ GRÉCIA Banheira

CARACTERÍSTICAS:

Castelos cerâmicos

Chuveiro de mão, suporte e flexível incluídos





DUCHE

À MEDIDA

+ CHUVEIROS De mão

FORMATO: Circular
DIMENSÃO: XL
CARACTERÍSTICAS:
Com 5 ou 1 função de massagem



+ CHUVEIROS De mão

FORMATO: Circular
DIMENSÃO: Standard
CARACTERÍSTICAS:
Com 5 funções de massagem



+ CHUVEIROS De mão

FORMATO: Circular / Quadrado
DIMENSÃO: Standard
CARACTERÍSTICAS:
Design minimal



+ CHUVEIROS Superiores

DIMENSÃO: XL
MODELOS: TOP / LUX
CARACTERÍSTICAS:
 Com cascata de água



+ CHUVEIROS Superiores

FORMATO: Circular / Quadrado
MODELOS: XL Slim
CARACTERÍSTICAS:
 Com ou sem cascata de água

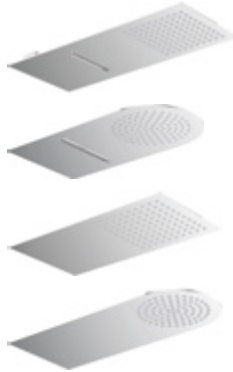

+ CHUVEIROS Superiores

FORMATO: Circular / Quadrado / Rectangular
MODELOS: Slim / Simples
MEDIDAS:
 Slim
 500 / 400 / 350 / 300 / 250mm
 Simples: quadrado / circular
 300 / 250 / 200mm
 Simples: rectangular
 400 x 300 / 300 x 200 / 150 x 200mm

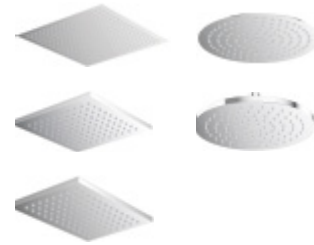

+ BRAÇOS À parede

APLICAÇÃO:
 Fixação de chuveiros superiores
FORMATOS: Circular / Quadrado
MEDIDAS:
 Circular: ponta redonda
 400 / 360 / 300mm
 Circular / Quadrado
 400 / 375 / 300mm

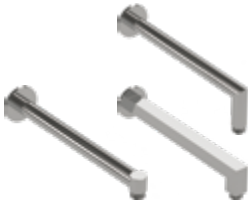

+ BRAÇOS Ao teto

APLICAÇÃO:
 Fixação de chuveiros superiores
FORMATOS: Circular / Quadrado
MEDIDAS:
 Circular
 300 / 250mm
 Quadrado
 300 / 250mm



+ SUPORTES Chuveiro

APLICAÇÃO:
 Suporte de chuveiros de mão
FORMATOS: Circular / Quadrado
CARACTERÍSTICAS:
 Com ou sem ligação de água



+ BARRAS Deslizantes

FORMATOS: Circular / Quadrado
CARACTERÍSTICAS:
 Com suporte para chuveiro de mão
 Com ou sem ligação de água



+ BANCOS Parede

MATERIAL:
 Poliuretano preto ou branco
CARACTERÍSTICAS:
 Rebatíveis



+ INJECTORES Parede

TIPOLOGIA: XL Fixos / Orientáveis
FORMATOS:
 XL Fixos
 Rectangulares / Quadrados / Circulares
 Orientáveis
 Quadrados / Circulares

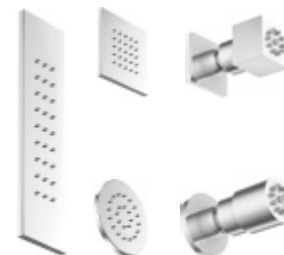

MODELOS E MEDIDAS

TORNEIRAS / GUIA RÁPIDO E DESENHOS TÉCNICOS

ORBIS



LAVATÓRIO

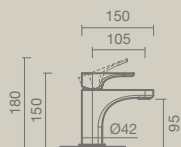

LAVATÓRIO cano alto

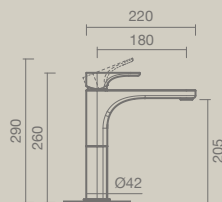

LAVATÓRIO de encastre

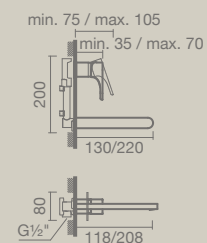

MOON



LAVATÓRIO

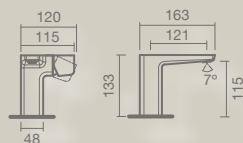

LAVATÓRIO cano alto

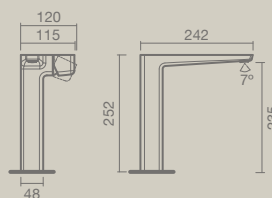

BIDÉ

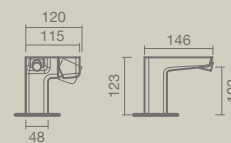

SILK



LAVATÓRIO

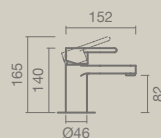

LAVATÓRIO cano alto

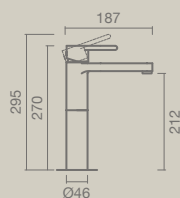

LAVATÓRIO de encastre

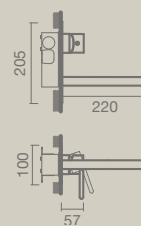

LAVATÓRIO de encastre

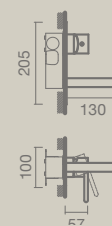

DUCHE / BANHEIRA 4 vias

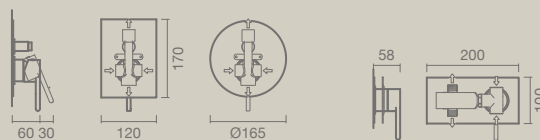

Versão termostática disponível

DUCHE / BANHEIRA 5 vias

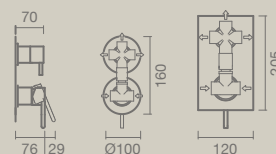

Versão termostática disponível

BIDÉ

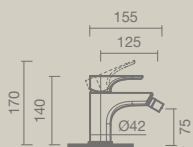

DUCHE 3 vias

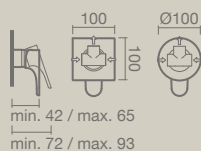

DUCHE 4 vias

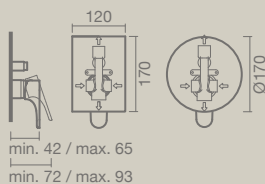

DUCHE

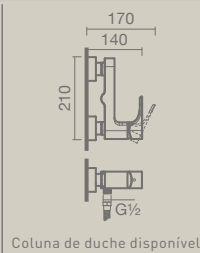

BANHEIRA

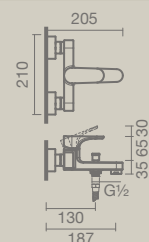

DUCHE



BANHEIRA

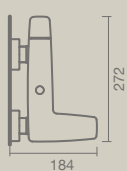

BIDÉ

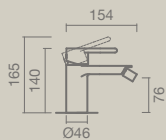

DUCHE

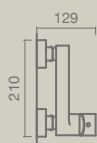

DUCHE 3 vias

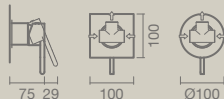

DUCHE / BANHEIRA 6 vias

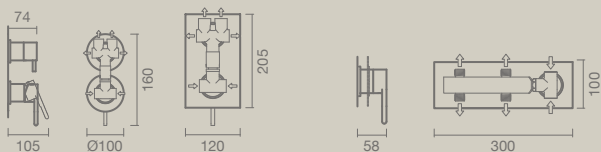

BANHEIRA

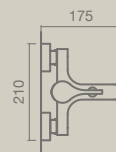

MODELOS E MEDIDAS

TORNEIRAS / GUIA RÁPIDO E DESENHOS TÉCNICOS

BALANCE



LAVATÓRIO

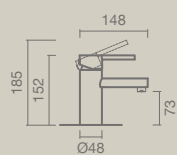

Modelo electrónico disponível

LAVATÓRIO cano alto

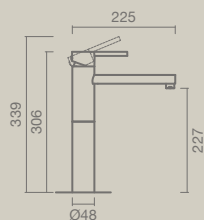

LAVATÓRIO de encastre



LAVATÓRIO de encastre



DUCHE / BANHEIRA 5 vias

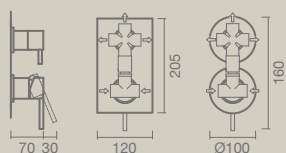

Versão termostática disponível

DUCHE / BANHEIRA 6 vias

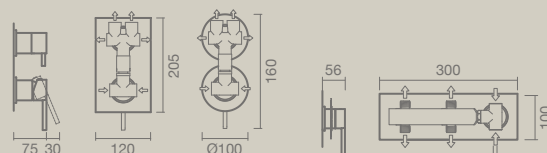

Versão termostática disponível

COSMO



LAVATÓRIO

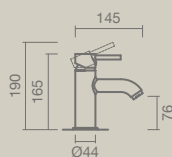

LAVATÓRIO cano alto

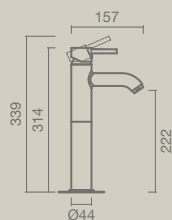

LAVATÓRIO de encastre



Modelo com bica longa disponível

LAVATÓRIO temporizada



Modelo electrónico disponível

DUCHE / BANHEIRA 4 vias

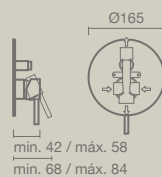

Versão termostática disponível

DUCHE / BANHEIRA 5 vias

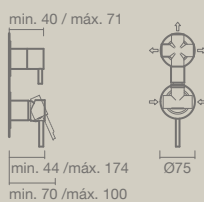

Versão termostática disponível

DUCHE / URINAL temporizada



BANHEIRA

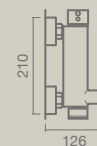

Modelo de encastre disponível

BIDÉ

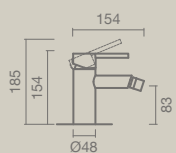

DUCHE

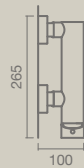

Versão termostática disponível

DUCHE 3 vias

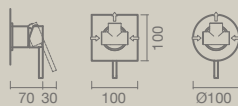

Versão termostática disponível

DUCHE / BANHEIRA 4 vias

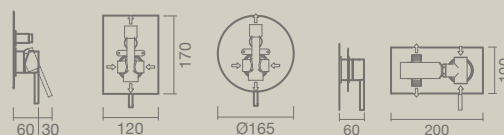

Versão termostática disponível

BANHEIRA

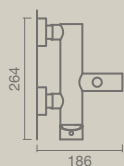

Versão termostática disponível

Coluna de duche e torneira de pé alto disponíveis

BIDÉ

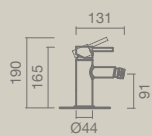

DUCHE



Coluna de duche disponível

DUCHE de encastre



DUCHE termostática

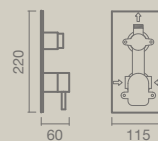

DUCHE 3 vias



Versão termostática disponível

BLOC



LAVATÓRIO

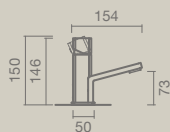

BIDÉ

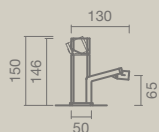

DUCHE



Coluna de duche disponível

BANHEIRA

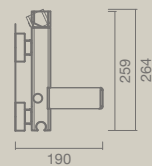

MODELOS E MEDIDAS

TORNEIRAS / GUIA RÁPIDO E DESENHOS TÉCNICOS

UNIC



LAVATÓRIO



Manipulo clínico disponível

LAVATÓRIO temporizada



1 ou 2 entradas de água disponíveis

LAVATÓRIO electrónico



1 ou 2 entradas de água disponíveis

LAVATÓRIO cano alto: temporizada

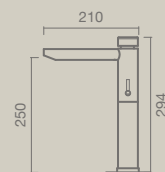

1 ou 2 entradas de água disponíveis

DUCHE

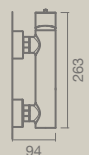

DUCHE column available

DUCHE 3 vias

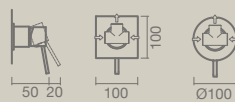

Versão termostática disponível

DUCHE / BANHEIRA 4 vias

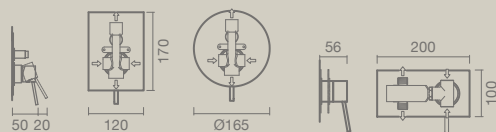

Versão termostática disponível

FLOW

Página 118



LAVATÓRIO

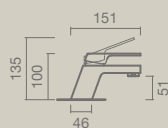

Modelo de encastre disponível

BIDÉ

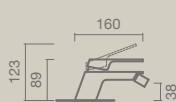

DUCHE

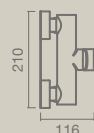

BANHEIRA

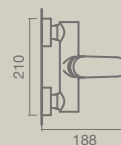

ART



LAVATÓRIO cascata aberta

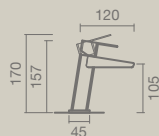

LAVATÓRIO cascata fechada

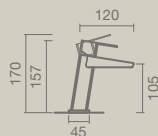

LAVATÓRIO arejador orientável

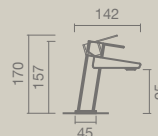

BIDÉ cascata fechada

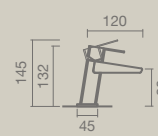

LAVATÓRIO cano alto

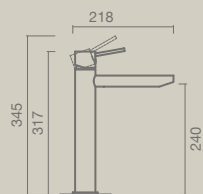

Modelo com 25cm de cano disponível

LAVATÓRIO electrónico

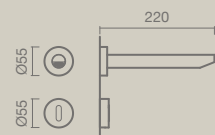

1 ou 2 entradas de água disponíveis

LAVATÓRIO de encastre

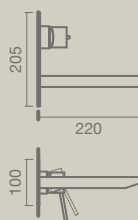

LAVATÓRIO de encastre



BIDÉ

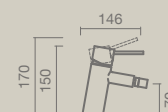

DUCHE / BANHEIRA 5 vias

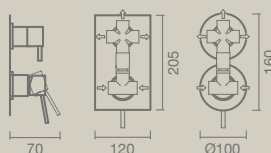

Versão termostática disponível

DUCHE / BANHEIRA 6 vias

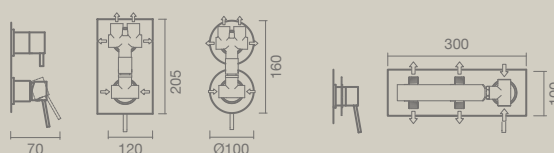

Versão termostática disponível

BANHEIRA

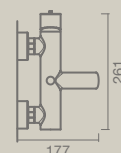

SELEKT



LAVATÓRIO

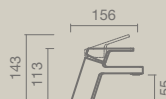

LAVATÓRIO cano alto

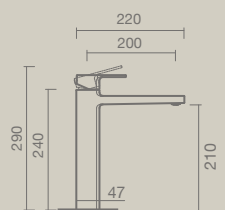

BIDÉ

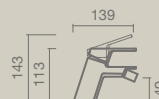

DUCHE

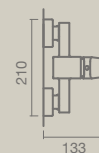

BANHEIRA

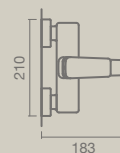

BIDÉ arejador orientável

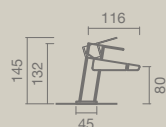

DUCHE

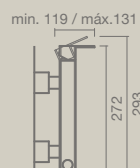

BANHEIRA

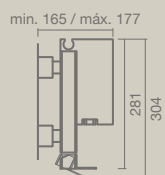

MODELOS E MEDIDAS

TORNEIRAS / GUIA RÁPIDO E DESENHOS TÉCNICOS

NOA

Página 124



LAVATÓRIO

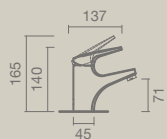

BIDÉ

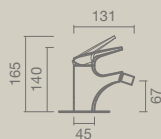

DUCHE

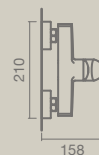

BANHEIRA

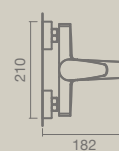

XS



LAVATÓRIO



BIDÉ



DUCHE

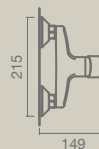

BANHEIRA

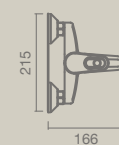

ATLAS 40



LAVATÓRIO manípulo clínico

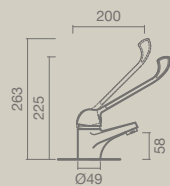

Manípulo standard disponível

BIDÉ manípulo clínico

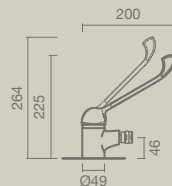

Manípulo standard disponível

DUCHE manípulo clínico

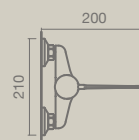

Manípulo standard disponível

BANHEIRA

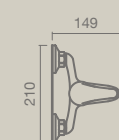

GRÉCIA



LAVATÓRIO

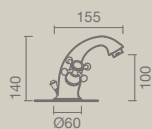

BIDÉ

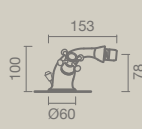

DUCHE

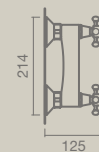

BANHEIRA

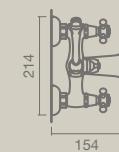



LAVATÓRIO

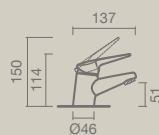

BIDÉ

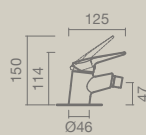

DUCHE

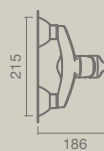

BANHEIRA

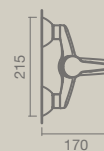



MÓVEIS



SUSTENTABILIDADE

Porque assumimos a nossa responsabilidade pelo impacto ambiente consequente das atividades industriais que nos estão associadas, procuramos adotar materiais e processos de fabrico sustentáveis no desenvolvimento da nossa gama de mobiliário para banho.



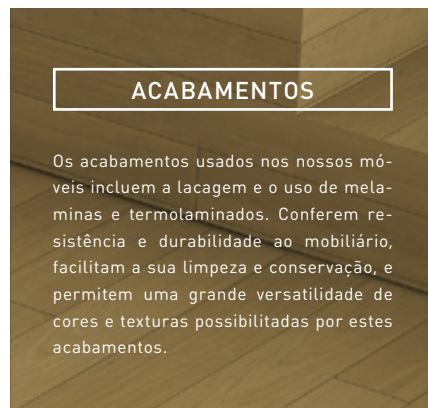
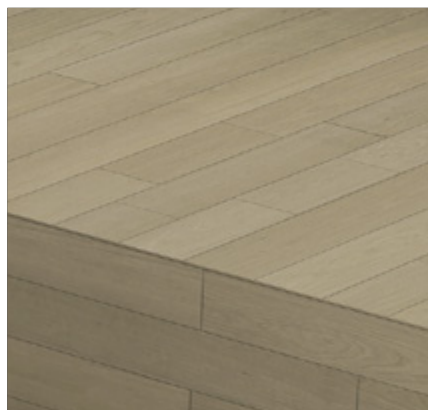
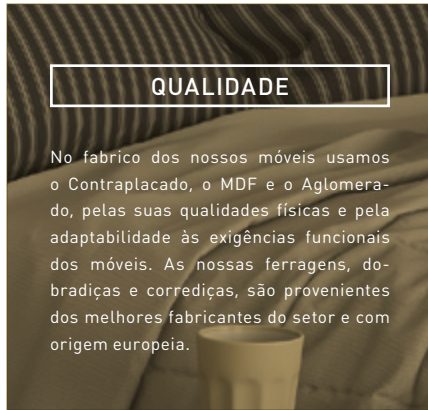

ARDEN

AO CHÃO



Móvel de chão ARDEN 80 em carvalho, lavatório SMOOTH 80 e torneira BALANCE



1 ARDEN 80

MEDIDAS:
780 x 530 x 845mm
CARACTERÍSTICAS:
Com duas portas



2 ARDEN 90

MEDIDAS:
880 x 530 x 845mm
CARACTERÍSTICAS:
Com duas portas



3 ARDEN 100

MEDIDAS:
980 x 530 x 845mm
CARACTERÍSTICAS:
Com duas portas



N
O
V
I
D
A
D
E

MÓVEIS



Móvel de chão ARDEN 100 em preto mate, lavatório SMOOTH 100 e torneira BALANCE para lavatório

+ ARDEN

APLICAÇÃO: Ao chão

MEDIDAS: 780 / 880 / 980 x 530 x 845 mm

CORES: Preto Mate + Branco / Carvalho + Branco

CARACTERÍSTICAS:

Compatíveis com lavatórios SMOOTH em solid surface com aba de 12mm de altura (não incluídos)

Estrutura do móvel em MDF hidrófugo de 19mm,

lacado a esmalte poliuretano branco mate no interior e exterior

Móvel com sub-tampo para sustentação do lavatório em

MDF hidrófugo de 22mm lacado a esmalte poliuretano branco mate

Pés em madeira maciça de faia com acabamento em velatura preta

ou em madeira maciça de carvalho com acabamento em verniz poliuretano

Portas em MDF hidrófugo de 16mm lacado a esmalte poliuretano branco

mate e dobradiças com abertura automática por pressão



Áreas de arrumação do móvel ARDEN 100

HARAPAN

AO CHÃO



Móvel ao chão HARAPAN 90 em preto mate, lavatório SMOOTH 90 e torneira BLOC para lavatório

+ HARAPAN

APLICAÇÃO: Ao chão

MEDIDAS: 780 / 880 / 980 x 530 x 845 mm

CORES: Preto Mate + Branco / Carvalho + Branco

CARACTERÍSTICAS:

Compatíveis com lavatórios SMOOTH em solid surface com aba de 12mm de altura (não incluídos)

Estrutura do móvel em MDF hidrófugo de 16mm, lacado a esmalte poliuretano branco mate no interior e exterior

Móvel com sub-tampo para sustentação do lavatório em MDF hidrófugo de 22mm lacado a esmalte poliuretano branco mate

Pés em madeira maciça de faia com acabamento em velatura preta ou em madeira maciça de carvalho com acabamento em verniz poliuretano

Gaveta com interior em MDF de 12mm laminado à cor branca e corredeiras ocultas com abertura automática por pressão

Espaços laterais de arrumação com interior em MDF de 16mm laminado à cor branca e dobradiças com abertura automática por pressão



MÓVEIS

Móvel ao chão HARAPAN 100 em carvalho, lavatório SMOOTH 100 e torneira BLOC para lavatório

1 HARAPAN 80

MEDIDAS:

780 x 530 x 845mm

CARACTERÍSTICAS:

Uma gaveta e dois espaços de arrumação laterais



2 HARAPAN 90

MEDIDAS:

880 x 530 x 845mm

CARACTERÍSTICAS:

Uma gaveta e dois espaços de arrumação laterais



3 HARAPAN 100

MEDIDAS:

980 x 530 x 845mm

CARACTERÍSTICAS:

Uma gaveta e dois espaços de arrumação laterais



N
O
V
I
D
A
D
E



Móvel suspenso STENIS 80 em carvalho, lavatório SMOOTH 80 torneira SELEKT e espelho ASTERION



Móvel STENIS 100 em cinza wengué



Áreas de arrumação do móvel STENIS 100

STENIS

SUSPENSO

1 STENIS 80

MEDIDAS: 800 x 530 x 600mm

CARACTERÍSTICAS:
Com uma gaveta



2 STENIS 90

MEDIDAS: 900 x 530 x 600mm

CARACTERÍSTICAS:
Com uma gaveta



3 STENIS 100

MEDIDAS: 900 x 530 x 600mm

CARACTERÍSTICAS:
Com uma gaveta



+ STENIS

APLICAÇÃO: Suspenso

CORES: Cinza Wengué (texturado) + Branco / Carvalho (texturado) + Branco

CARACTERÍSTICAS:

Compatíveis com lavatórios SMOOTH em solid surface com aba de 150mm de altura (não incluídos)

Estrutura em MDF 16mm com acabamento em melamina texturada na cor carvalho ou cinza wengué

Gaveta com exterior em MDF de 12mm lacado a esmalte poliuretano branco mate e interior em MDF laminado de 12mm na cor branca

Gaveta com corredeiras ocultas e abertura automática por pressão

WEZA

DE CHÃO



Móvel de chão WEZA em cinza wengué com lavatório SMOOTH de aba 12, torneiras MOON e louça suspensa CORAL

+ WEZA

APLICAÇÃO: De chão

MEDIDAS:

980 / 780 / 630 x 485 x 700mm (Lavatórios AIDA)

780 x 530 x 780mm (vendido em pack com lavatório SMOOTH com aba de 50)

780 x 530 x 830mm (vendido em pack com lavatório SMOOTH com aba de 12)

CORES: Preto Mate + Cinza Wengué (com SMOOTH ou AIDA) ou Inox com acabamento natural + Wengué (apenas com AIDA)

CARACTERÍSTICAS:

Compatível com lavatórios em solid surface SMOOTH (aba 12 ou 50) ou lavatórios cerâmicos AIDA

Estrutura em aço inoxidável:

com acabamento à cor natural (apenas nas versões com lavatórios AIDA) ou lacado a preto mate (nas versões com lavatórios AIDA ou SMOOTH)

Gavetas em aglomerado de 16mm com frente em aglomerado de 19mm e laterais em chapa de aço lacada:

revestida a folha de madeira composta em cor cinza wengué ou melamina em cor wengué natural (apenas nas versões com lavatórios AIDA)

Gavetas com corrediças silenciosas e sistema de fecho amortecido



Móvel de chão WEZA 80 em wengué com lavatório AIDA 80 e torneira BALANCE



Móvel de chão WEZA e lavatório SMOOTH (aba 50)

1 WEZA 65

PARA:
AIDA 65
MEDIDAS:
630 x 485 x 700mm
CARACTERÍSTICAS:
De chão
Com uma gaveta



2 WEZA 80

PARA:
AIDA 80
MEDIDAS:
780 x 485 x 700mm
CARACTERÍSTICAS:
De chão
Com uma gaveta



3 WEZA 100

PARA:
AIDA 100
MEDIDAS:
980 x 485 x 700mm
CARACTERÍSTICAS:
De chão
Com uma gaveta



5 WEZA 80

Com:
SMOOTH 80 (aba 12)
MEDIDAS:
780 x 530 x 842mm
CARACTERÍSTICAS:
De chão
Com uma gaveta



4 WEZA 80

Com:
SMOOTH 80 (aba 50)
MEDIDAS:
780 x 530 x 830mm
CARACTERÍSTICAS:
De chão
Com uma gaveta



YANKARI

SUSPENSO



Móvel suspenso YANKARI 100 em wengué, lavatório ARENA 70 e torneira UNIC de encastre

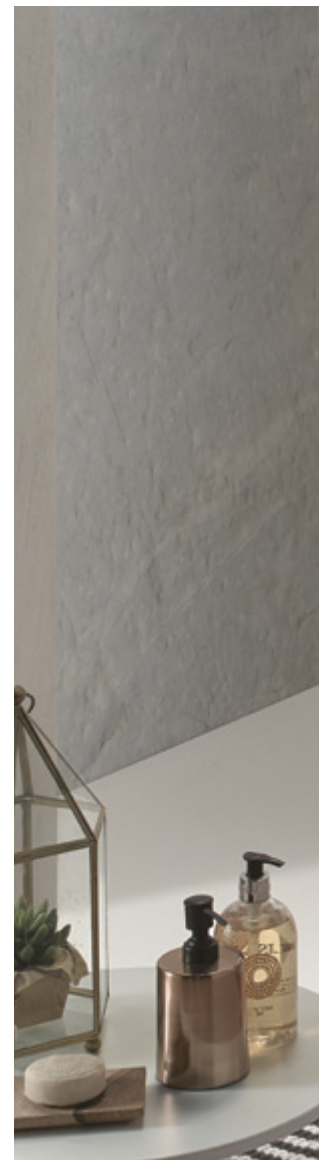

1 YANKARI 60

MEDIDAS:
600 x 460 x 440mm
CARACTERÍSTICAS:
Com duas gavetas



2 YANKARI 80

MEDIDAS:
800 x 460 x 440mm
CARACTERÍSTICAS:
Com duas gavetas



3 YANKARI 90

MEDIDAS:
900 x 460 x 440mm
CARACTERÍSTICAS:
Com duas gavetas



4 YANKARI 100

MEDIDAS:
1000 x 460 x 440mm
CARACTERÍSTICAS:
Com duas gavetas





Móvel suspenso YANKARI 80 em cinza wengué com lavatório ARENA 38 e torneira UNIC de encastre

MÓVEIS

+ YANKARI

APLICAÇÃO: Suspenso

MEDIDAS: 600 / 800 / 900 / 1000 x 460 x 440 mm

CORES: Wengué / Cinza Wengué

CARACTERÍSTICAS:

Compatível com lavatórios de pousar

Estrutura em MDF hidrófugo de 16mm com juntas sem emendas e bancada de 30mm: lacada a esmalte poliuretano de alto brilho na cor branca no exterior e interior do móvel

Gavetas em aglomerado de 16mm com frentes em MDF hidrófugo de 16mm: revestido a folha composta de madeira natural (wengué ou cinza wengué) com face e contra face envernizadas em poliuretano

Gavetas com corredeiras ocultas e sistema de abertura automática por pressão



Áreas de arrumação do móvel YANKARI 100

TAHOE

SUSPENSO



Móvel suspenso TAHOE 80 em branco e cinza wengué e lavatório SMILE 80



1 TAHOE 60

MEDIDAS:

595 x 456 x 490mm

CARACTERÍSTICAS:

Com duas gavetas

Com ou sem bancada

2 TAHOE 80

MEDIDAS:

795 x 456 x 490mm

CARACTERÍSTICAS:

Com duas gavetas

Com ou sem bancada

3 TAHOE 90

MEDIDAS:

895 x 456 x 490mm

CARACTERÍSTICAS:

Com duas gavetas

Com ou sem bancada

4 TAHOE 100

MEDIDAS:

995 x 456 x 490mm

CARACTERÍSTICAS:

Com duas gavetas

Com ou sem bancada

4 TAHOE 120

MEDIDAS:

1195 x 456 x 490mm

CARACTERÍSTICAS:

Com duas gavetas

Com ou sem bancada



Móvel suspenso TAHOE 90 em cinza e branco, lavatório UP oval e torneira BALANCE de parede



Áreas de arrumação do móvel TAHOE 100

+ TAHOE

APLICAÇÃO: Suspenso

MEDIDAS: 595 / 795 / 895 / 995 / 1195 x 456 x 490mm

CORES: Cinza / Carvalho / Cinza Wengué / Wengué

CARACTERÍSTICAS:

Compatível com lavatórios de encastre ou de pousar (com bancada)

Estrutura em MDF hidrófugo de 16mm:

lacado a esmalte poliuretano de alto brilho (branco ou cinza) ou revestida a folha de madeira natural (carvalho) com face e contra face envernizadas

Gavetas em aglomerado de 16mm com frentes em MDF hidrófugo de 16mm:

lacadas a esmalte poliuretano de alto brilho (branco ou cinza) ou revestidas a folhas de madeira natural (carvalho ou cinza wengué) com face e contra face envernizadas

Gavetas com corredeiras ocultas e sistema de fecho amortecido:

com puxadores integrados na estrutura da gaveta

Opcional: aplicação de bancada no mesmo material da estrutura do móvel

DIXIE

SUSPENSO



Móvel suspenso DIXIE 60 em branco e cinza, lavatório SMILE 60 e torneira BALANCE para lavatório

+ DIXIE

APLICAÇÃO: Suspenso

MEDIDAS:

595 / 795 / 995 x 456 x 490mm

CORES: Branco / Cinza / Carvalho

CARACTERÍSTICAS:

Compatível com lavatórios de encastre ou de pousar (com bancada)

Estrutura em MDF hidrófugo de 16mm:

lacado a esmalte poliuretano de alto brilho (branco ou cinza)

Gavetas em aglomerado de 16mm com frentes em MDF hidrófugo de 16mm:

lacadas a esmalte poliuretano de alto brilho (branco ou cinza) ou revestidas a folhas de madeira natural (carvalho) com face e contra face envernizadas

Gavetas com corrediças ocultas e sistema de abertura automática por pressão

Porta(s) com dobradiças com mola e sistema de abertura automática por pressão

Opcional: aplicação de bancada no mesmo material da estrutura do móvel



Móvel suspenso DIXIE 80 em branco e carvalho com lavatório UP circular

1 DIXIE 60

MEDIDAS:

595 x 456 x 490mm

CARACTERÍSTICAS:

Com uma gaveta
Com ou sem bancada

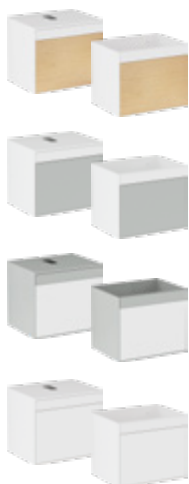

2 DIXIE 80

MEDIDAS:

795 x 456 x 490mm

CARACTERÍSTICAS:

Com uma gaveta e porta
Com ou sem bancada



3 DIXIE 100

MEDIDAS:

995 x 456 x 490mm

CARACTERÍSTICAS:

Com uma gaveta e duas portas
Com ou sem bancada



CUBIC

SUSPENSO



Móvel suspenso CUBIC 50 com lavatório sobre móvel CUBIC 50

1 CUBIC 50

MEDIDAS: 480 x 337 x 550mm

CARACTERÍSTICAS:

Compatível com:
lavatório CUBIC 50
Com duas portas



2 CUBIC 60

MEDIDAS: 580 x 337 x 550mm

CARACTERÍSTICAS:

Compatível com:
lavatório CUBIC 60
Com duas portas



3 CUBIC 80

MEDIDAS: 780 x 337 x 550mm

CARACTERÍSTICAS:

Compatível com:
lavatório CUBIC 80
Com duas portas





MÓVEIS

Móvel suspenso CUBIC 80 com lavatório sobre móvel CUBIC 80

+ CUBIC

APLICAÇÃO: Suspenso

MEDIDAS: 480 / 580 / 780 x 337 x 550mm

CORES: Branco

CARACTERÍSTICAS:

Estrutura em MDF hidrófugo de 19mm:

lacado a branco de alto brilho no exterior com prateleira em aglomerado de 16mm

Interior das portas com área útil para arrumação

(possibilidade de regulação da altura da prateleira)

Travessa frontal de suporte ao lavatório em MDF de 25mm: lacado a branco

Portas em MDF hidrófugo de 16+44mm lacado nas 2 faces:

com porta-objectos em vidro e dobradiças de abertura automática por pressão

Profundidade reduzida (cerca de 35cm) para rentabilização do espaço

Cumpr com requisitos da norma EN14749-2005



Áreas de arrumação do móvel CUBIC 80



Área de arrumação do móvel suspenso GLAM 90 em branco com lavatório de pousar GLAM 55 e torneira SILK



Móvel GLAM 70 em wengué e lavatório GLAM 70



Áreas de arrumação do móvel GLAM 70 em wengué

GLAM

SUSPENSO

1 GLAM 70

MEDIDAS: 690 x 465 x 405mm

CARACTERÍSTICAS:

Compatível com:

lavatório GLAM 70

Com uma gaveta e gaveta interna com organizador para pequenos objectos



2 GLAM 70

MEDIDAS: 690 x 465 x 420mm

CARACTERÍSTICAS:

Compatível com:

lavatórios de pousar

Com uma gaveta e gaveta interna com organizador para pequenos objectos



3 GLAM 90

MEDIDAS: 900 x 475 x 216mm

CARACTERÍSTICAS:

Compatível com:

lavatórios de pousar

Com uma gaveta



+ GLAM

APLICAÇÃO: Suspenso

CORES: Branco / Wengué

CARACTERÍSTICAS:

Estrutura em MDF lacado em branco alto brilho ou aglomerado revestido a chapa de melanina na cor wengué

Bancada e frente em contraplacado: revestido a termolaminado de alta pressão na cor wengué ou lacado a branco alto brilho (resistente à humidade)

Gaveta exterior com sistema de abertura automática por pressão

Gaveta interior com divisória para pequenos objectos [disponível apenas nos móveis de 70cm]

CASUAL

SUSPENSO



Área de arrumação do móvel CASUAL 80



Móvel suspenso CASUAL 80 com bancada, lavatório de pousar UP, torneira SELEKT e base de chuveiro AXIS

+ CASUAL

APLICAÇÃO: Suspenso

MEDIDAS:
597 / 799 x 467 / 473 x 282 / 304mm

CORES: Branco

CARACTERÍSTICAS:

Estrutura em MDF lacado em alto brilho na cor branca

Gaveta com sistema de abertura automática por pressão

OPCIONAL: aplicação de bancada em MDF hidrófugo de 22mm lacado a branco alto brilho

1 CASUAL Bancada

MEDIDAS:
597 / 799 x 467 / 474 x 304mm

CARACTERÍSTICAS:

Compatível com:
lavatórios de pousar
Com uma gaveta



2 CASUAL

MEDIDAS:
597 / 799 x 466 / 473 x 282mm

CARACTERÍSTICAS:

Compatível com:
lavatórios CASUAL 80 e 60
Com uma gaveta





Móvel suspenso CUBE 42 com gavetas em wengué

1 CUBE 33 - Portas

MEDIDAS: 485 / 585 x 325 x 740mm

CARACTERÍSTICAS:

Com lavatório cerâmico próprio (reversível):

32,5cm de profundidade e furação para torneira lateral (ESQ / DIR)

Possibilidade de aplicação de par de pés em alumínio (altura: 120mm)

Com duas portas



2 CUBE 42 - Portas

MEDIDAS: 435 / 535 / 635 / 785 x 420 x 740mm

CARACTERÍSTICAS:

Com lavatório cerâmico próprio:

42cm de profundidade e furação central para torneira

Possibilidade de aplicação de par de pés em alumínio (altura: 120mm)

Com duas portas



3 CUBE 42 - Gavetas

MEDIDAS: 435 / 535 / 635 / 785 x 420 x 550mm

CARACTERÍSTICAS:

Com lavatório cerâmico próprio:

42cm de profundidade e furação central para torneira

Possibilidade de aplicação de par de pés em alumínio (altura: 300mm)

Sistema de gavetas corrediço com fecho amortecido

Com duas gavetas



CUBE

SUSPENSO



Móvel suspenso CUBE 42 com portas em branco, lavatório próprio e torneira NOA para lavatório

MÓVEIS

+ CUBE

APLICAÇÃO: Suspenso

CORES: Branco / Wengué

CARACTERÍSTICAS:

Inclui lavatório cerâmico com furo ladrão e furação para torneira

Estrutura e gavetas / portas em aglomerado de 16mm:

revestidas a melamina na cor wengué ou branco lacado com topos frontais em PVC na cor alumínio

Sistema de portas com fecho amortecido (de fabrico europeu)

Puxador/perfil em alumínio com acabamento mate

Sistema de fixação mural regulável

Com possibilidade de aplicação de par de pés em alumínio



Coluna e móvel INYO 80 em antracite com lavatório SMILE 80, torneira UNIC para lavatório e espelho HEKA



+ INYO

APLICAÇÃO: Suspensão

CORES: Branco / Antracite / Carvalho / Wengué

CARACTERÍSTICAS:

Lavatório SMILE e sifão incluídos na compra do móvel

Estruturas e frentes em aglomerado 16mm:

lacado a branco ou antracite ou revestido a melamina na cor carvalho ou wengué

Fixação à parede ajustável em altura e profundidade

Puxadores em alumínio anodizado

Móvel:

> Gavetas com corredeiras com fecho amortecido e interior em aglomerado de 13mm com acabamento em PVC têxtil

> Portas em aglomerado de 16mm com dobradiças com fecho amortecido

Coluna:

> Portas com dobradiças com fecho amortecido

> Inclui quatro prateleiras ajustáveis e uma prateleira fixa

INYO

SUSPENSO

1 INYO Portas

MEDIDAS: 600 / 800 x 460 x 720mm

CARACTERÍSTICAS:

Com duas portas



2 INYO Gavetas

MEDIDAS: 600 / 800 x 460 x 720mm

CARACTERÍSTICAS:

Com duas gavetas



3 INYO Coluna

MEDIDAS: 345 x 250 x 1500mm

CARACTERÍSTICAS:

Reversível

Disponível em: antracite, wengué, carvalho e branco





PETIT

SUSPENSO



Móvel suspenso PETIT em cor nogueira com lavatório PETIT e torneira SILK

+ PETIT

APLICAÇÃO: Suspenso

MEDIDAS: 395 x 225 x 600mm

CORES: Branco / Antracite / Nogueira / Wengué

CARACTERÍSTICAS:

Disponível em 2 PACKs:

- > lavatório cerâmico PETIT com 22,5cm de profundidade, furo ladrão e furação lateral para torneira
- > lavatório cerâmico PETIT com 22,5cm de profundidade, furo ladrão e furação lateral para torneira e espelho UNUK 80 x 40

Estrutura e porta em aglomerado de 16mm:

lacado a branco ou antracite ou revestido a melamina nogueira ou wengué

Puxador em alumínio com acabamento acetinado

Porta reversível

Dobradiças com sistema de fecho amortecido

COOL

SUSPENSO



Móvel suspenso COOL 80 em cor wengué com lavatório SMILE 80 e torneira SILK para lavatório

MÓVEIS

+ COOL

APLICAÇÃO: Suspenso

MEDIDAS: 595 / 795 / 895 x 457 x 450mm

CORES: Nogueira / Wengué

CARACTERÍSTICAS:

Compatível com: lavatórios SMILE 60, 80 e 90

Estrutura e portas em aglomerado de

madeira revestido a melamina

Dobradiças com sistema de fecho amortecido



ESPELHOS

MURAIS



Espelho ORION 80 com iluminação LED nas laterais

1 ORION

MEDIDAS:
800 / 900 / 1000 x 600mm
CARACTERÍSTICAS:
Iluminação LED nas laterais
Moldura em *solid surface*
Sensor de movimento
Desembaciador
Fixação: horizontal



2 POLARIS

MEDIDAS: 800 / 1000 x 700mm
CARACTERÍSTICAS:
Iluminação LED
Estrutura em alumínio
Controlo *bluetooth*
Desembaciador
Fixação: horizontal



3 ASTERION

MEDIDAS: 800 x 800mm
CARACTERÍSTICAS:
Iluminação LED a toda a volta
Estrutura em alumínio



4 ANTARES

MEDIDAS: 800 / 1000 / 1200 x 600 mm
CARACTERÍSTICAS:
Espelho de aumento com
iluminação LED a toda a volta
Sensor de movimento
Desembaciador
Fixação: horizontal / vertical



5 MAYARA

MEDIDAS:
800 / 1000 / 1200 x 600 mm
CARACTERÍSTICAS:
Iluminação LED a toda a volta
Desembaciador
Estrutura em alumínio
Fixação: horizontal / vertical



6 NAOS

MEDIDAS:
800 / 1000 / 1200 x 600 mm
CARACTERÍSTICAS:
Iluminação LED
Controlo de intensidade de luz
Desembaciador
Estrutura em alumínio
Fixação: horizontal / vertical



7 SIRIUS

MEDIDAS:
800 / 1000 / 1200 x 600 mm
CARACTERÍSTICAS:
Iluminação LED
Desembaciador
Moldura em alumínio
Fixação: horizontal / vertical



8 HEKA

MEDIDAS:
800 / 1000 / 1200 x 600 mm
CARACTERÍSTICAS:
Moldura em alumínio
Fixação: horizontal / vertical



9 KUMA

MEDIDAS:
800 / 1000 / 1200 x 600 mm
CARACTERÍSTICAS:
Cantos redondos
Fixação: horizontal / vertical



10 UNUK

MEDIDAS:
800 / 1000 / 1200 x 600 mm
CARACTERÍSTICAS:
Cantos retos
Fixação: horizontal / vertical



11 UNUK

MEDIDAS:
800 x 400 mm
CARACTERÍSTICAS:
Cantos retos
Fixação: horizontal / vertical



12 VEGA

MEDIDAS:
600 x 800 mm
CARACTERÍSTICAS:
Moldura em inox
Movimento basculante
Fixação: vertical



13 APLIQUE

CARACTERÍSTICAS:
Aplique de iluminação
Em alumínio anodizado mate



ARDEN HAR. STENIS WEZA YANKARI TAHOE DIXIE CUBIC GLAM CASUAL CUBE INYO COOL PETIT

	ARDEN	HAR.	STENIS	WEZA	YANKARI	TAHOE	DIXIE	CUBIC	GLAM	CASUAL	CUBE	INYO	COOL	PETIT
Branco							•	•	•	•	•	•		•
Cinza						•	•							
Antracite												•		•
Cinza Wengué			•	•	•	•								
Wengué				•	•	•			•		•	•	•	•
Nogueira													•	•
Carvalho	•	•	•			•	•					•		
Preto Mate	•	•												

STENIS 80, 90 e 100

Página 146

STENIS 80, 90 e 100 compatíveis com lavatórios SMOOTH 80, 90 e 100 (com aba de 150)

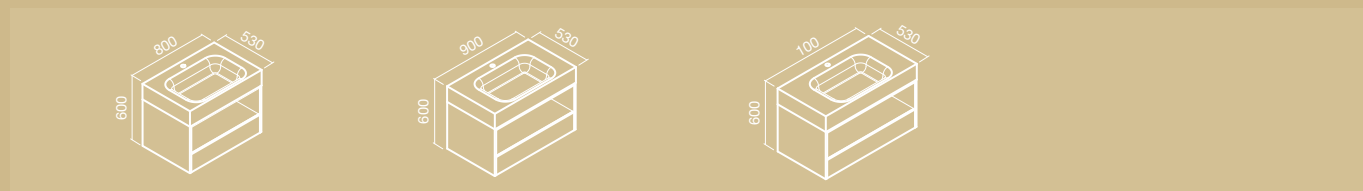

WEZA 80 para SMOOTH

Página 148

WEZA 80 compatível com lavatórios SMOOTH (com abas de 12 e 50mm)

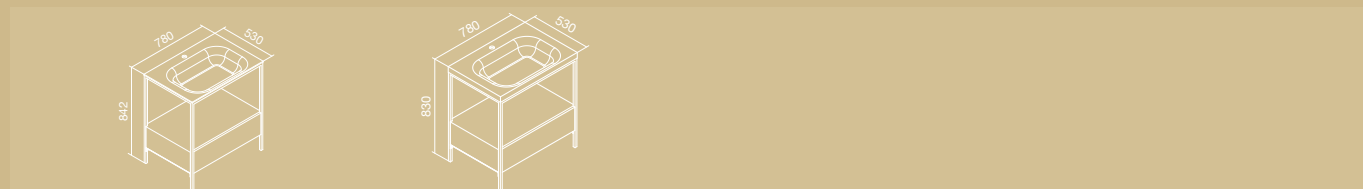

Página 150

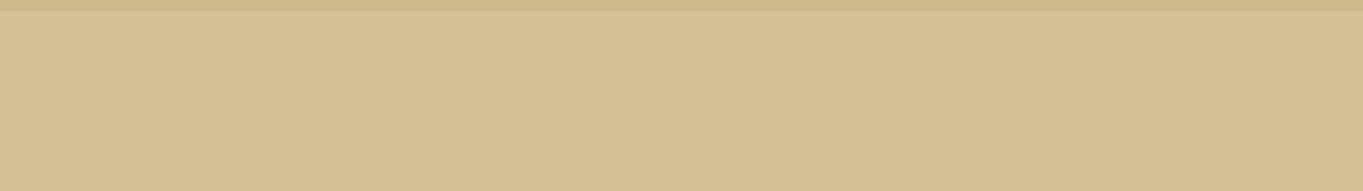

Página 152

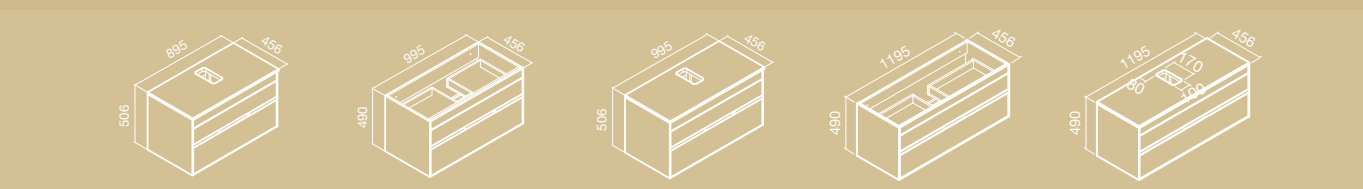

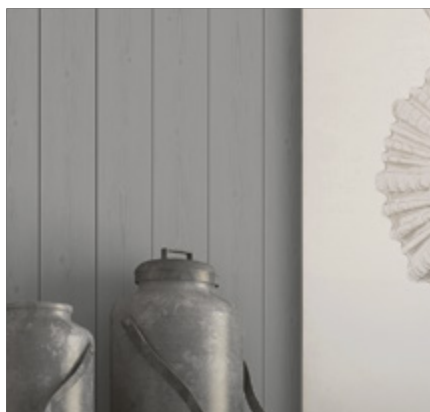

ACESSÓRIOS

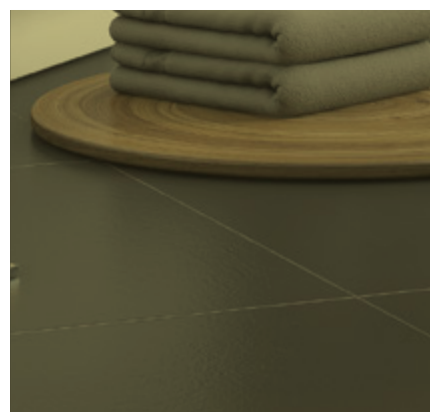

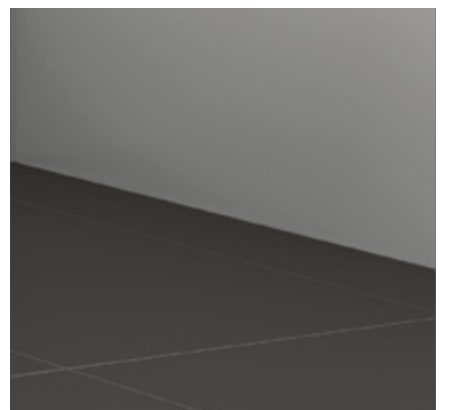
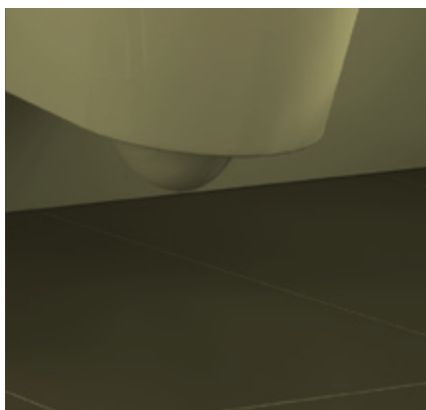
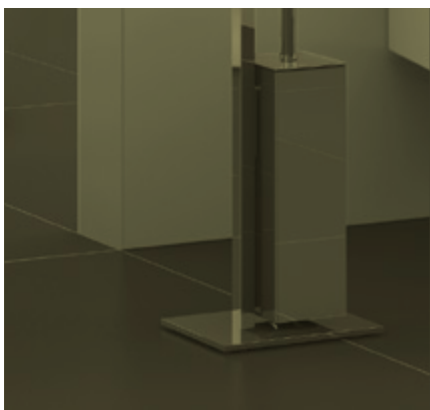

ESSENCE



Toalheiro 600, caixote de lixo de WC, dispensador de sabão de pousar e dispensador de lenços ESSENCE

1 PRATELEIRA C/ PORTA-COPO

APLICAÇÃO: Mural
CARACTERÍSTICAS:
Em vidro com fixações em zamak
10 Anos de garantia



2 DISPENSADOR DE SABÃO

APLICAÇÃO: Mural
CARACTERÍSTICAS:
Em vidro e latão cromado
10 Anos de garantia



3 PORTA-PIAÇABA

APLICAÇÃO: Mural
CARACTERÍSTICAS:
Em vidro, zamak e aço inoxidável
10 Anos de garantia



4 CABIDE

APLICAÇÃO: Mural
CARACTERÍSTICAS:
 Em zamak
 10 Anos de garantia

**5 TOALHEIROS**

APLICAÇÃO: Mural
CARACTERÍSTICAS:
 Em zamak com fixações em aço inoxidável
 10 Anos de garantia

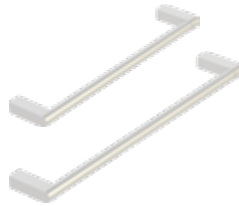
**6 TOALHEIRO DE ARGOLA**

APLICAÇÃO: Mural
CARACTERÍSTICAS:
 Em zamak com fixação em latão cromado
 10 Anos de garantia

**7 DISPENSADOR DE SABÃO**

APLICAÇÃO: De posar / Mural
CARACTERÍSTICAS:
 Em zamak com fixações
 em latão cromado
 10 Anos de garantia

**8 PORTA-ROLO**

APLICAÇÃO: Mural
CARACTERÍSTICAS:
 Em zamak com fixações
 em aço inoxidável
 10 Anos de garantia

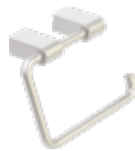

Porta-piçaba, porta-rolô e toalheiro ESSENCE 400 com louça sanitária CORAL suspensa



Toalheiro de parede ESSENCE

9 TOALHEIRO DE PAREDE

APLICAÇÃO: Mural
CARACTERÍSTICAS:
100% Latão cromado
10 Anos de garantia

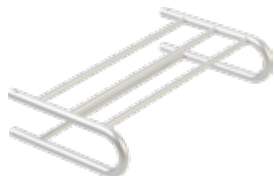

10 DISPENSADOR DE LENÇOS

APLICAÇÃO: De pousar / Mural
CARACTERÍSTICAS:
Em aço inoxidável
10 Anos de garantia

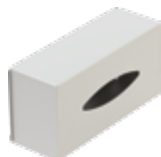

11 CAIXOTE DO LIXO

APLICAÇÃO: De pousar
CARACTERÍSTICAS:
Em aço inoxidável
10 Anos de garantia





ACESSÓRIOS

Toalheiro 600, caixote de lixo de WC, dispensador de sabão de pousar e dispensador de lenços ESSENCE

CONNECT

ROUND . SQUARE . BLACK



Toalheiro 300 e saboneteira CONNECT Square com lavatório UP



1 SABONETEIRA

APLICAÇÃO: Mural
CARACTERÍSTICAS:
100% Latão cromado
10 Anos de garantia

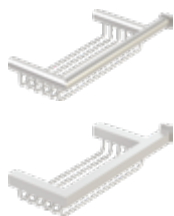

2 TOALHEIROS

APLICAÇÃO: Mural
MEDIDAS: 600 / 500 / 300mm
CARACTERÍSTICAS:
100% Latão cromado / lacado preto mate
10 Anos de garantia

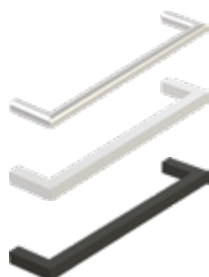



ACESSÓRIOS

Porta-toalha duplo de pé alto e porta-piaçaba/rolo + toalheiro CONNECT Square com banheira QUEEN e sanita GLAM

3 CABIDES

APLICAÇÃO: Mural

CARACTERÍSTICAS:

100% Latão cromado / lacado preto mate

10 Anos de garantia / Pack 2 unidades



4 PORTA-ROLO

APLICAÇÃO: Mural

CARACTERÍSTICAS:

100% Latão cromado / lacado preto mate

10 Anos de garantia



5 PORTA-ROLO Reserva

APLICAÇÃO: Mural

CARACTERÍSTICAS:

100% Latão cromado / lacado preto mate

10 Anos de garantia

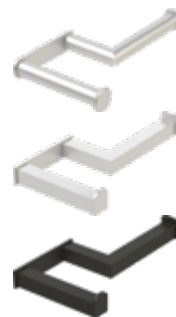

6 PORTA-ROLO ESQ / DIR

APLICAÇÃO: Mural

CARACTERÍSTICAS:

100% Latão cromado / lacado preto mate

10 Anos de garantia

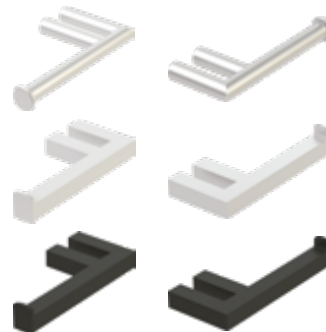

7 PORTA-PIAÇABA

APLICAÇÃO:

De pousar / Mural

CARACTERÍSTICAS:

100% Latão cromado / lacado preto mate

10 Anos de garantia

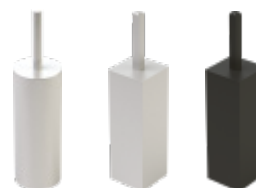

Porta-rolô com reserva e porta-piçaba de pousar CONNECT Round



Porta-toalha duplo de pé alto CONNECT Round

8 PORTA-PIAÇABA / ROLO

APLICAÇÃO: De pousar

CARACTERÍSTICAS:

Com toalheiro (apenas versões CONNECT Round e Square)

100% Latão cromado / lacado preto mate

10 Anos de garantia



9 PORTA-TOALHA Duplo

APLICAÇÃO: De pousar

CARACTERÍSTICAS:

100% Latão cromado

100% Latão lacado a preto mate

10 Anos de garantia



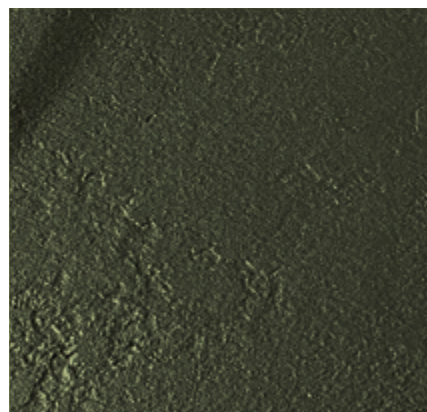
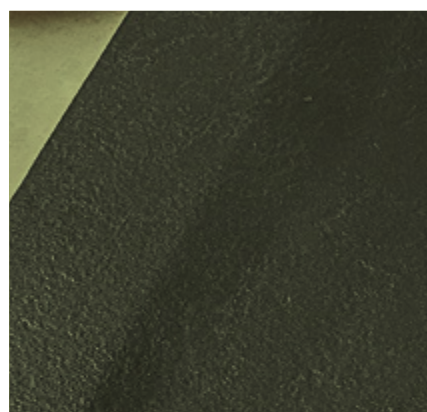
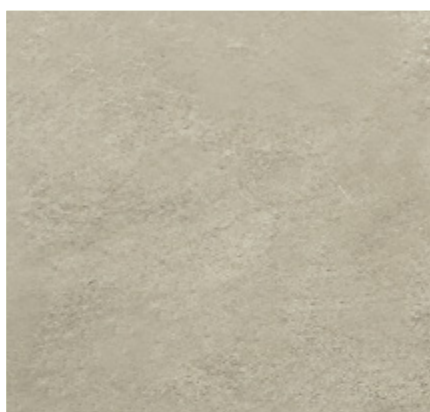
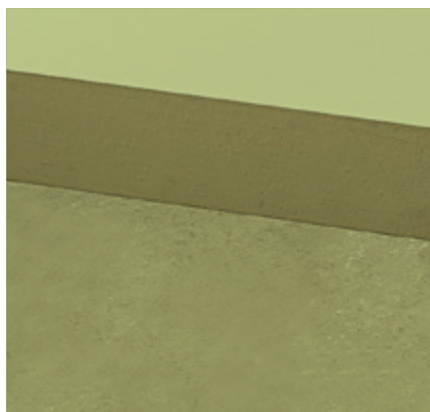

BASES

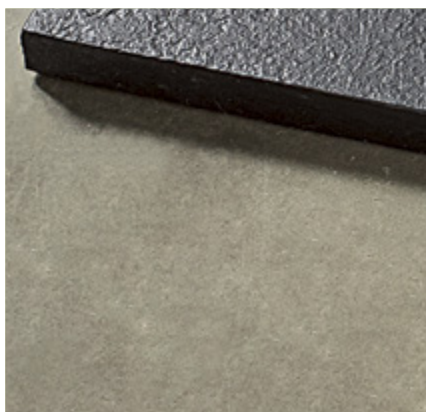
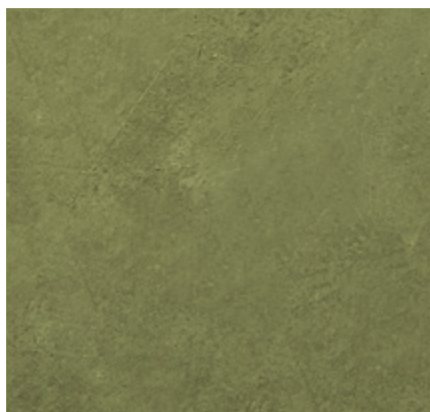

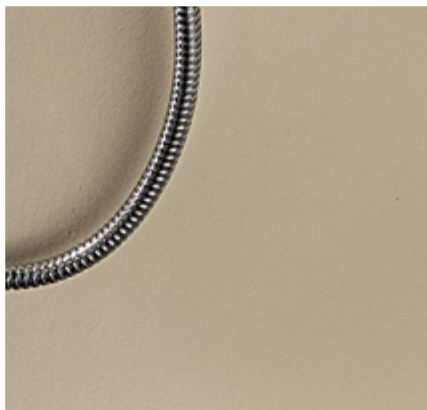
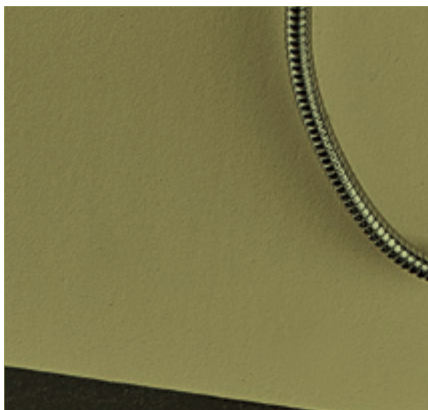

DIVERSIDADE

Vários formatos e uma ampla gama de medidas marcam o portfólio de bases Sanitana. Desde bases com dimensões tão pequenas como 700 x 700mm até bases com 2000 x 900mm (ideais para a renovação de áreas de banho ocupadas por banheiras), a oferta é vasta e ajustada às suas necessidades.

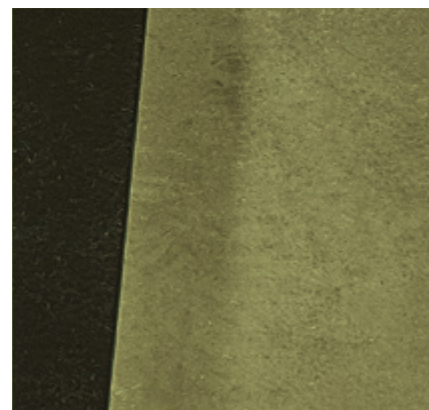
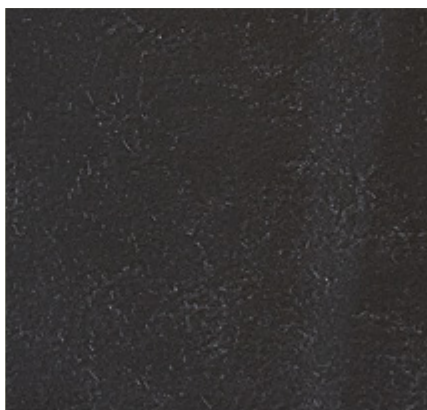
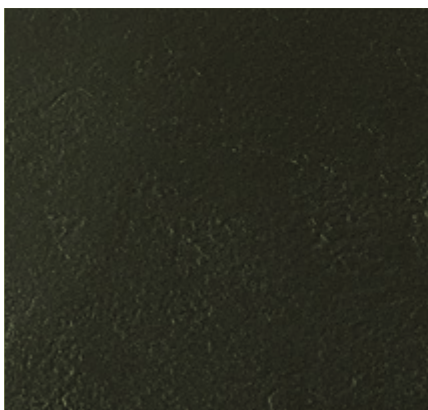
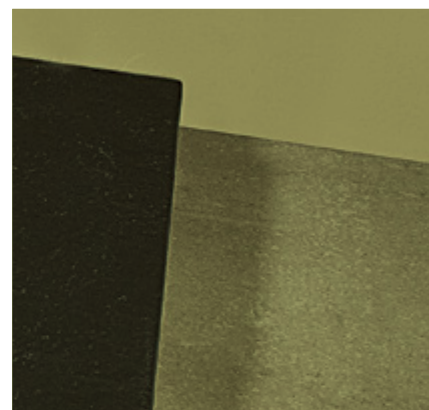

MATERIAIS

As nossas bases de chuveiro são produzidas em chapa acrílica termo conformada e reforçada com fibra de vidro para lhes conferir resistência; chapa de aço esmaltada; em cerâmica; e o novo material compósito STONEX®. Em suma: variedade sem descuidar a performance de cada produto.



ROCKS

DE POUSAR



Base de chuveiro ROCKS quadrada branca

+ ROCKS

TIPOLOGIAS:

De posar

CORES: Branco / Antracite / Preto

MEDIDAS:

2000 / 1900 / 1800 / 1700 / 1600 / 1500 / 1400 / 1300 / 1200 / 1100 / 1000 / 900 x 900 x 30mm

2000 / 1900 / 1800 / 1700 / 1600 / 1500 / 1400 / 1300 / 1200 / 1100 / 1000 / 900 x 800 x 30mm

1600 / 1500 / 1400 / 1300 / 1200 / 1100 / 1000 / 900 x 700 x 30mm

CARACTERÍSTICAS:

Em Stonex®

Superfície texturada e efeito antiderrapante

Base extraplana ideal para aplicação de divisórias Sanitana

Válvula de descarga sifonada Ø90 com tampa em aço inox incluída

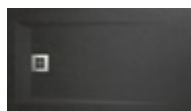
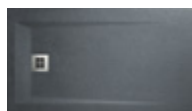

STONEX®

Material compósito constituído por resina de poliéster combinada com cargas mine-rais e superfície em gel coat com 500µ (micras). Com um acabamento texturado de cor uniforme para máximo conforto e segurança (antiderrapante), é resistente ao desgaste, impacto, choques térmicos e descoloração pelos raios UV e agressões por agentes químicos.



32 MEDIDAS, ÂNGULOS DE 90°

Com 32 medidas de grandes formatos (2000 a 900mm de comprimento) e ângulos de 90°, as bases ROCKS são ideais para substituir uma banheira por uma base, facilitando a sua instalação.



BASE EXTRAPLANA

Com uma superfície plana de 30mm e a possibilidade de encaixe perfeito com o pavimento, a base de chuveiro ROCKS é ideal para aplicação de divisórias SANITANA.

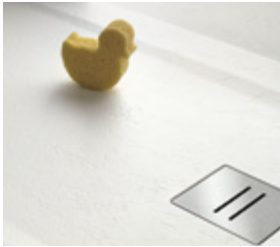

ACABAMENTO TEXTURADO

Com um acabamento texturado, semelhante ao da pedra natural, as bases de chuveiro ROCKS garantem o máximo de conforto e segurança, pelo seu efeito antiderrapante. Estão disponíveis nas cores: branco, antracite e preto.

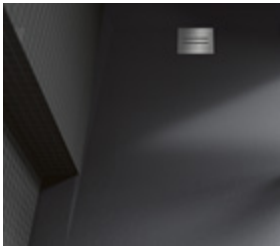

ADAPTA-SE AO SEU ESPAÇO

Com possibilidade de corte à medida em obra e posterior acabamento em todas as laterais, as bases de chuveiro ROCKS adaptam-se verdadeiramente ao seu espaço.



VÁLVULA CENTRADA

Mesmo com um corte à medida, a válvula de esgoto da base de chuveiro ROCKS permanece centrada sob o seu eixo longitudinal, facilitando a sua instalação.



TAMPA EM AÇO INOXIDÁVEL

Equipada com uma válvula de Ø90mm com tampa em aço inoxidável (AISI 304), permite a saída de água até 0,6l por segundo, assegurando não só o conforto na hora do duche, como a durabilidade dos próprios materiais.



Base de chuveiro ROCKS branca

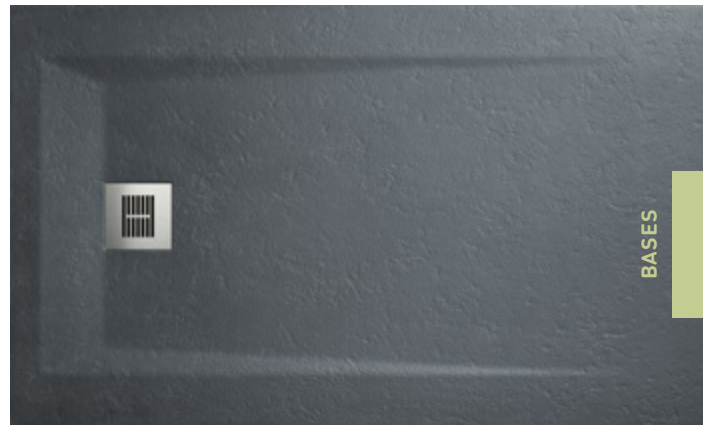

Base de chuveiro ROCKS antracite

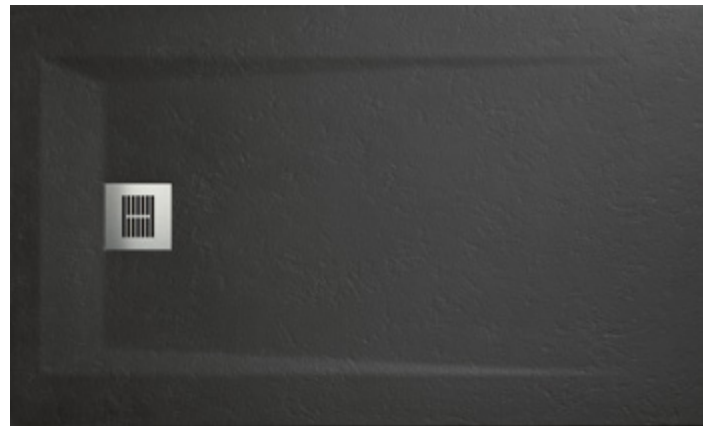

Base de chuveiro ROCKS preta

JULIA

DE ENCASTRE / MURETE
DE POUSAR

+ JULIA

TIPOLOGIAS:

De encastre / De pousar

CORES: Branco / Pergamon (sob consulta)

CARACTERÍSTICAS:

Antiderrapante (alguns modelos)

Utiliza válvula de Ø65 (não incluída)

Em chapa acrílica sanitária com acabamento brilho



Base de chuveiro JULIA quadrada antiderrapante

1 JULIA Quadrada

APLICAÇÃO:

De encastre / Murete

MEDIDAS:

900 / 800 / 700 x 35mm

Lisa

900 / 800 / 700 x 35mm

Antiderrapante



APLICAÇÃO:

De pousar

MEDIDAS:

900 / 800 / 700 x 75mm

Antiderrapante

800 / 700 x 150mm

Antiderrapante



2 JULIA Rectangular

APLICAÇÃO:

De encastre / Murete

MEDIDAS:

900 x 750 x 35mm

Lisa / Antiderrapante

1600/1400/1200/1000 x 800 x 35mm

Antiderrapante



APLICAÇÃO:

De pousar

MEDIDAS:

900 x 750 x 35mm

1600/1400/1200/1000 x 800 x 75mm

Antiderrapante



Base de chuveiro JULIA rectangular antiderrapante



Base de chuveiro VITA rectangular com coluna YN

VITA

DE POUSAR



Base de chuveiro VITA quadrada



Base de chuveiro VITA angular

BASES

+ VITA

TIPOLOGIAS:

De pousar

CORES: Branco

CARACTERÍSTICAS:

Extraplana e antiderrapante

Utiliza válvula de Ø90 de alto débito (56l/m) com tampa em latão cromado (não incluída)

Em chapa acrílica sanitária com acabamento brilho

1 VITA Angular

MEDIDAS:

1000 / 900 / 800 x 55mm



2 VITA Quadrada

MEDIDAS:

1000 / 900 / 800 x 55mm



3 VITA Rectangular

MEDIDAS:

1800 / 1700 / 1600 / 1500 / 1400 / 1300 / 1200 / 1100 / 1000 x 800 x 55mm
1600 / 1400 / 1200 / 1000 x 900 x 55mm





Base de chuveiro ESFERA rectangular

ESFERA

DE POUSAR

+ ESFERA

TIPOLOGIAS:

De posar

CORES: Branco

CARACTERÍSTICAS:

Antiderrapante

Utiliza válvula de Ø55 (não incluída)

Em chapa acrílica sanitária com acabamento brilho



Base de chuveiro ESFERA quadrada

1 ESFERA Angular

MEDIDAS:

900 / 800 x 80mm



2 ESFERA Quadrada

MEDIDAS:

1000 / 900 / 800 x 80mm



3 ESFERA Rectangular

MEDIDAS:

1700 / 1600 / 1500 / 1400 / 1300 / 1200 / 1100 / 1000 x 700 x 80mm



LINE

DE POUSAR



Base de chuveiro LINE

BASES

+ LINE

TIPOLOGIAS:
De posar

CORES: Branco

MEDIDAS:
1200 x 750 x 35mm

CARACTERÍSTICAS:
Extraplana
Com válvula de Ø90 incluída
Em chapa acrílica sanitária
com acabamento brilho



ANABELA

DE POUSAR



Base de chuveiro ANABELA rectangular

+ ANABELA

TIPOLOGIAS:

De pousar

CORES: Branco / Pergamon (sob consulta)

CARACTERÍSTICAS:

Antiderrapante

Utiliza válvula de Ø65 (não incluída)

1 ANABELA Angular

MEDIDAS:
800 x 800 x 80mm



2 ANABELA Quadrada

MEDIDAS:
800 / 700 x 80mm



3 ANABELA Rectangular

MEDIDAS:
900 x 720 x 80mm



JULIETA

DE POUSAR

1 JULIETA Angular

MEDIDAS:
900 x 900 x 80mm



2 JULIETA Quadrada

MEDIDAS:
900 x 900 x 80mm



3 JULIETA Rectangular

MEDIDAS:
1200 / 1000 x 800 / 700 x 80mm



+ JULIETA

TIPOLOGIAS:

De pousar

CORES: Branco / Pergamon (sob consulta)

CARACTERÍSTICAS:

Antiderrapante

Utiliza válvula de Ø65 (não incluída)

Base de chuveiro JULIETA quadrada

SLIM

DE POUSAR



SLIM

TIPOLOGIAS:

De posar

CORES: Branco / Preto Brilhante

CARACTERÍSTICAS:

Extraplana e antiderrapante

Com válvula de Ø90 incluída

Em chapa de aço esmaltada de 3,5mm de espessura

30 anos de garantia

1 SLIM Rectangular

MEDIDAS:

1400 / 1200 x 800 x 30mm



2 SLIM Quadrada

MEDIDAS:

1000 / 900 x 30mm



STANDARD

DE ENCASTRE / MURETE

1 STANDARD Quadrada

MEDIDAS:

700 x 700 x 135mm

900 / 800 x 145mm

Antiderrapante



2 STANDARD Angular

MEDIDAS:

700 x 700 x 120mm



+ STANDARD

TIPOLOGIAS:

De encastre / Murete

CORES: Branco

CARACTERÍSTICAS:

Antiderrapante (alguns modelos)

Compatível com válvula de Ø55 (não incluída)

Em chapa de aço esmaltada de 2mm de espessura



Base de chuveiro AXIS rectangular em branco

BASES

AXIS

DE POUSAR

+ AXIS

TIPOLOGIAS:

De posar

CORES: Branco Brilhante / Preto Mate

MEDIDAS:

1400 / 1200 x 900 x 30mm

CARACTERÍSTICAS:

Extraplana e antiderrapante

Com placas de insonorização

Com válvula de Ø90 incluída

Em chapa de aço esmaltada de 3,5cm de espessura

Juntas perfeitas e abas com ângulos exactos a 90°

Adaptada às normas de acessibilidade























30 anos de garantia

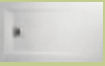
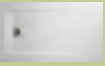

Detalhe da superfície antiderrapante da base AXIS preta

MODELOS E MEDIDAS

GAMA DE BASES DE CHUVEIRO RECTANGULARES / GUIA RÁPIDO

	2000	1900	1800	1700	1600	1500
900	 ROCKS . Pág. 186	 ROCKS . Pág. 186	 ROCKS . Pág. 186	 ROCKS . Pág. 186	 ROCKS . Pág. 186	 ROCKS . Pág. 186
					 VITA . Pág. 189	
800	 ROCKS . Pág. 186	 ROCKS . Pág. 186	 ROCKS . Pág. 186	 ROCKS . Pág. 186	 ROCKS . Pág. 186	 ROCKS . Pág. 186
			 VITA . Pág. 189	 VITA . Pág. 189	 VITA . Pág. 189	 VITA . Pág. 189
					 JULIA . Pág. 188	
750						
700					 ROCKS . Pág. 186	 ROCKS . Pág. 186
				 ESFERA . Pág. 190	 ESFERA . Pág. 190	 ESFERA . Pág. 190

1400

1300

1200

1100

1000

900

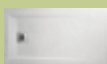

ROCKS . Pág. 186

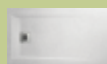

ROCKS . Pág. 186

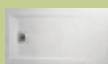

ROCKS . Pág. 186



ROCKS . Pág. 186



ROCKS . Pág. 186

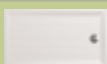

VITA . Pág. 189

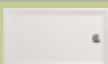

VITA . Pág. 189

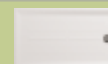

VITA . Pág. 189



AXIS . Pág. 195



AXIS . Pág. 195

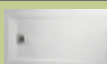

ROCKS . Pág. 186

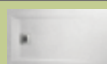

ROCKS . Pág. 186

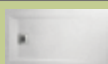

ROCKS . Pág. 186

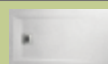

ROCKS . Pág. 186



ROCKS . Pág. 186



ROCKS . Pág. 186

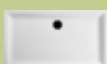

VITA . Pág. 189



VITA . Pág. 189



VITA . Pág. 189



VITA . Pág. 189



VITA . Pág. 189

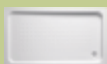

JULIA . Pág. 188

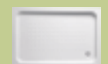

JULIA . Pág. 188



JULIA . Pág. 188

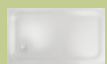

SLIM . Pág. 194

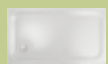

SLIM . Pág. 194



JULIETA . Pág. 193



JULIETA . Pág. 193

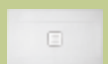

LINE . Pág. 191



JULIA . Pág. 188

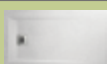

ROCKS . Pág. 186

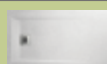

ROCKS . Pág. 186

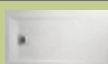

ROCKS . Pág. 186



ROCKS . Pág. 186



ROCKS . Pág. 186



ROCKS . Pág. 186



ESFERA . Pág. 190

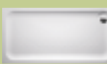

ESFERA . Pág. 190



ESFERA . Pág. 190



ESFERA . Pág. 190



ESFERA . Pág. 190



JULIETA . Pág. 193























JULIETA . Pág. 193



ANABELA . Pág. 192

MODELOS E MEDIDAS

BASES DE CHUVEIRO QUADRADAS E ANGULARES / GUIA RÁPIDO

1000 x 1000	900 x 900	800 x 800	700 x 700
	 <p>ROCKS . Pág. 186</p>		
 <p>VITA . Pág. 189</p>	 <p>VITA . Pág. 189</p>	 <p>VITA . Pág. 189</p>	
	 <p>JULIA . Pág. 188</p>	 <p>JULIA . Pág. 188</p>	 <p>JULIA . Pág. 188</p>
	 <p>JULIA . Pág. 188</p>	 <p>JULIA . Pág. 188</p>	 <p>JULIA . Pág. 188</p>
 <p>ESFERA . Pág. 190</p>	 <p>ESFERA . Pág. 190</p>	 <p>ESFERA . Pág. 190</p>	
	 <p>JULIETA . Pág. 193</p>		
		 <p>ANABELA . Pág. 192</p>	 <p>ANABELA . Pág. 192</p>
 <p>SLIM . Pág. 194</p>	 <p>SLIM . Pág. 194</p>		
	 <p>STANDARD . Pág. 194</p>	 <p>STANDARD . Pág. 194</p>	 <p>STANDARD . Pág. 194</p>

1000 x 1000

900 x 900

800 x 800

700 x 700



VITA . Pág. 189



VITA . Pág. 189



VITA . Pág. 189



ESFERA . Pág. 190



ESFERA . Pág. 190



JULIETA . Pág. 193



ANABELA . Pág. 192



STANDARD . Pág. 194

MODELOS E MEDIDAS

BASES DE CHUVEIRO / GUIA RÁPIDO E DESENHOS TÉCNICOS

ROCKS

Página 186

STONEX®

LARGURA: 900 / ABA: 30mm

LARGURA: 800 / ABA: 30mm

LARGURA: 700 / ABA: 30mm

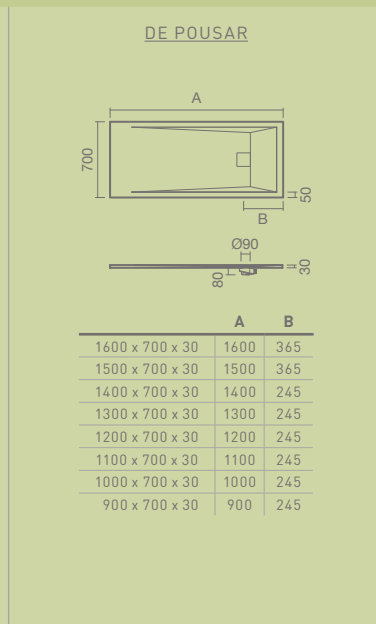
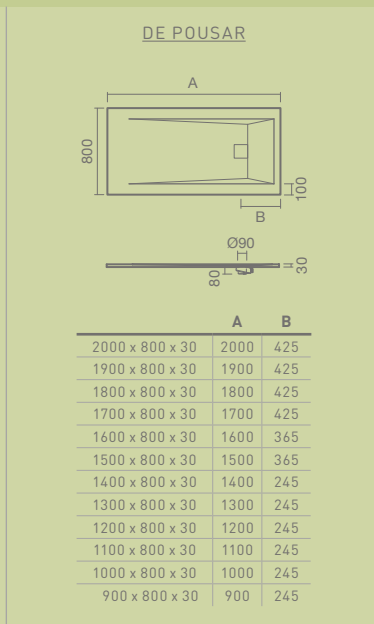
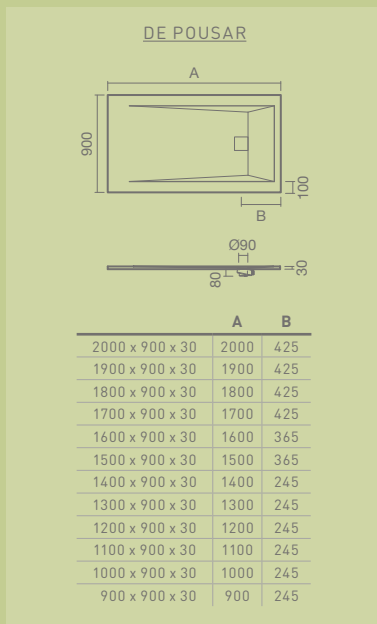

JULIA

ACRÍLICA

CUBA: 140 / ABA: 35mm

CUBA: 50 / ABA: 35mm

CUBA: 50 / ABA: 75mm

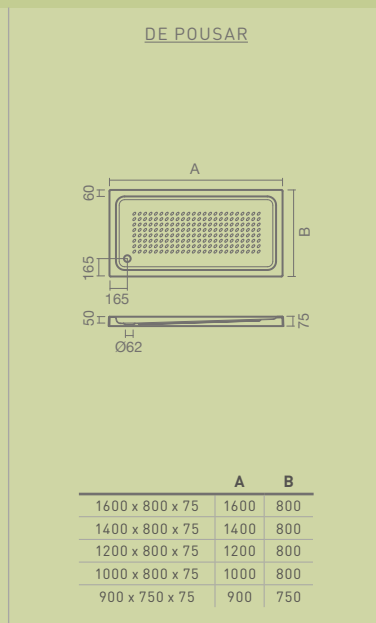
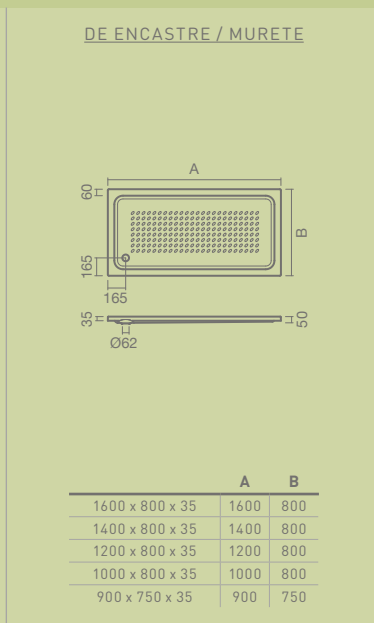
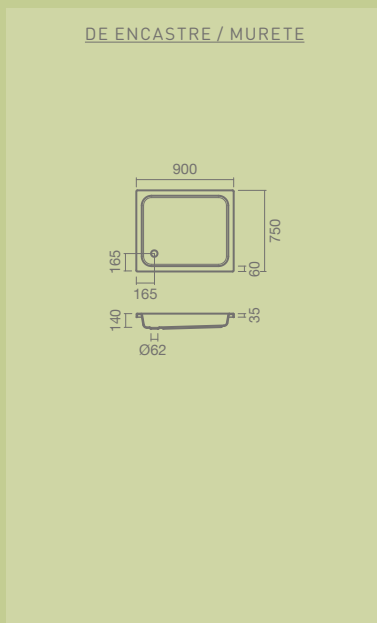

ACRÍLICA

CUBA: 35 / ABA: 55mm

CUBA: 35 / ABA: 55mm

CUBA: 35 / ABA: 55mm

CUBA: 35 / ABA: 55mm



DE POUSAR

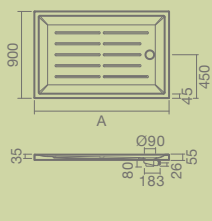

A	
1600 x 900 x 55	1600
1400 x 900 x 55	1400
1200 x 900 x 55	1200
1000 x 900 x 55	1000

DE POUSAR

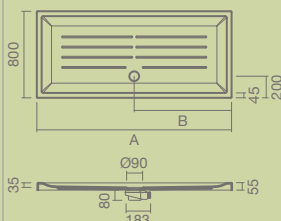

A	B
1800 x 800 x 55	1800 900
1700 x 800 x 55	1700 850
1600 x 800 x 55	1600 800
1500 x 800 x 55	1500 750
1400 x 800 x 55	1400 700
1300 x 800 x 55	1300 650
1200 x 800 x 55	1200 600
1100 x 800 x 55	1100 550
1000 x 800 x 55	1000 500

DE POUSAR

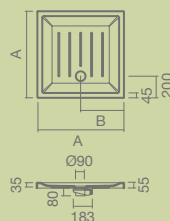

A	B
1000 x 1000 x 55	1000 500
900 x 900 x 55	900 450
800 x 800 x 55	800 400

DE POUSAR

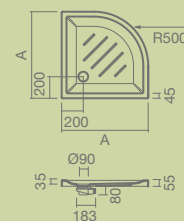

A	
1000 x 1000 x 55	1000
900 x 900 x 55	900
800 x 800 x 55	800

CUBA: 150 / ABA: 35mm

CUBA: 80 / ABA: 150mm

CUBA: 50 / ABA: 75mm

CUBA: 50 / ABA: 35mm

DE ENCASTRE / MURETE

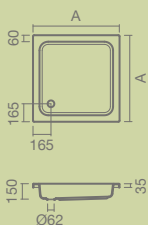

A	
900 x 900 x 35	900
800 x 800 x 35	800
700 x 700 x 35	700

DE POUSAR

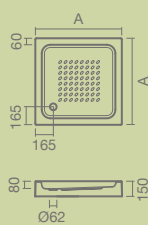

A	
800 x 800 x 150	800
700 x 700 x 150	700

DE POUSAR

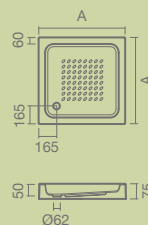

A	
900 x 900 x 75	900
800 x 800 x 75	800
700 x 700 x 75	700

DE ENCASTRE / MURETE

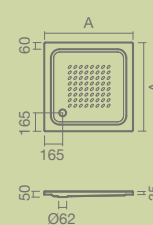

A	
900 x 900 x 35	900
800 x 800 x 35	800
700 x 700 x 35	700

MODELOS E MEDIDAS

BASES DE CHUVEIRO / GUIA RÁPIDO E DESENHOS TÉCNICOS

ESFERA

Página 190

ACRÍLICA

CUBA: 50 / ABA: 80mm

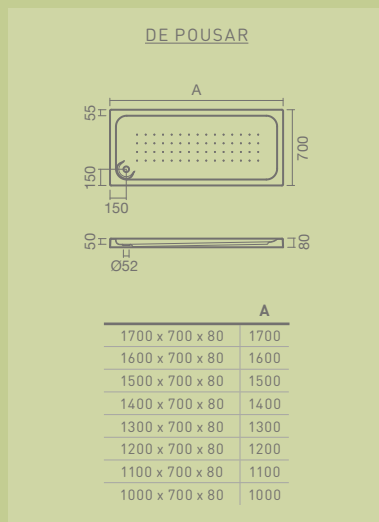

CUBA: 50 / ABA: 80mm

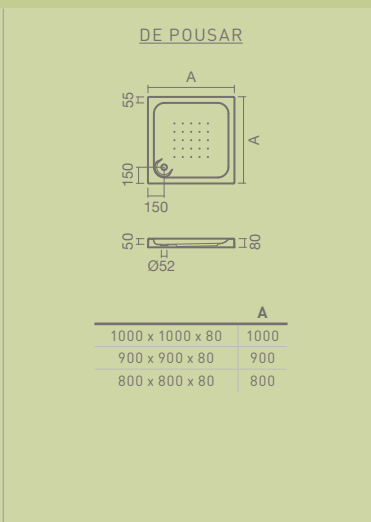

CUBA: 50 / ABA: 80mm

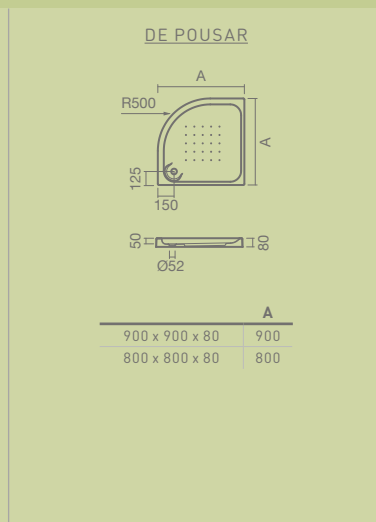

LINE

Página 191

ACRÍLICA

ABA: 35mm

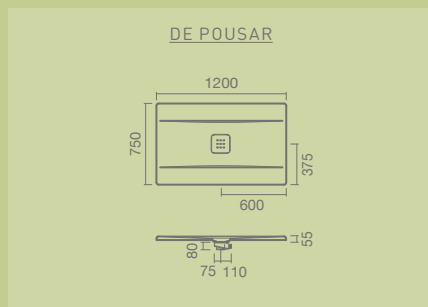

AXIS

Página 195

AÇO ESMALTADO

ABA: 30mm

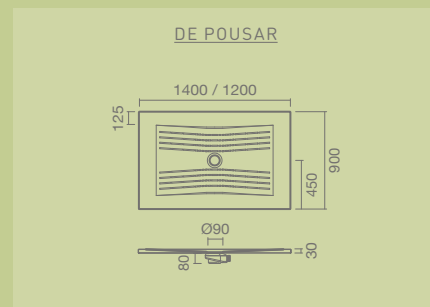
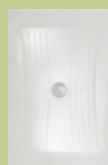

ANABELA

Página 192

CERÂMICA

CUBA: 50 / ABA: 80mm

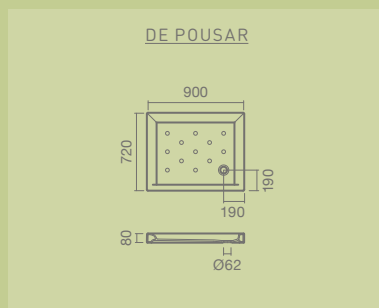

CUBA: 50 / ABA: 80mm

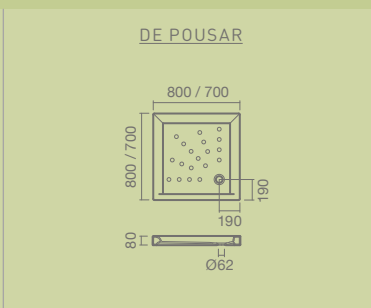

CUBA: 50 / ABA: 80mm

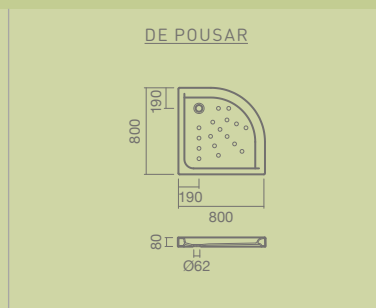

JULIETA

Página 193

CERÂMICA

CUBA: 50 / ABA: 80mm

CUBA: 50 / ABA: 80mm

CUBA: 50 / ABA: 80mm

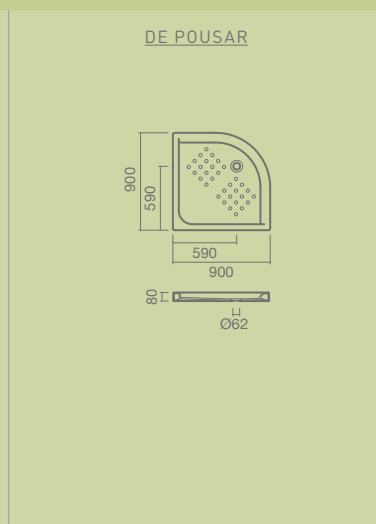
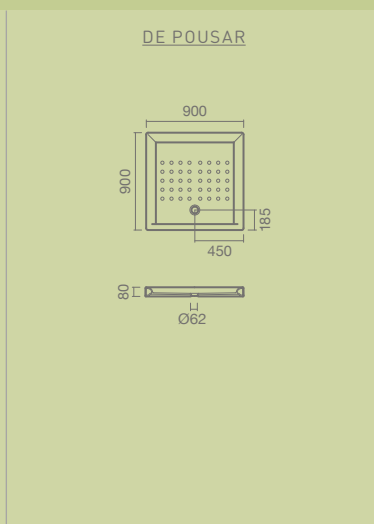
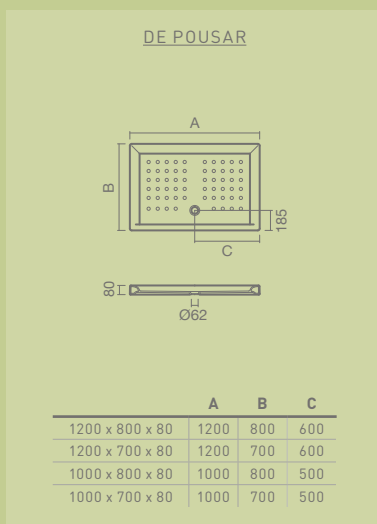

SLIM

Página 194

AÇO ESMALTADO

ABA: 30mm

ABA: 30mm

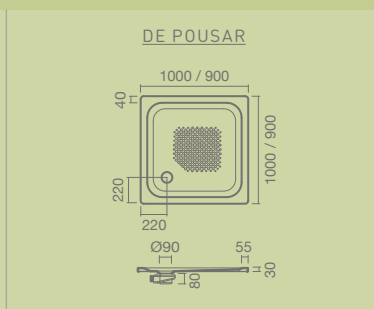
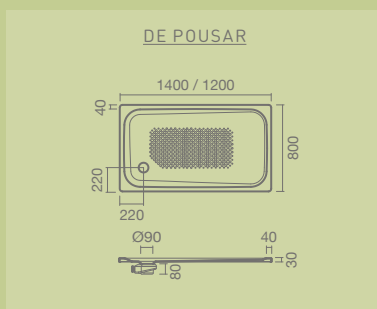

STANDARD

Página 194

AÇO ESMALTADO

ABA: 28mm

CUBA: 120 / ABA: 21mm

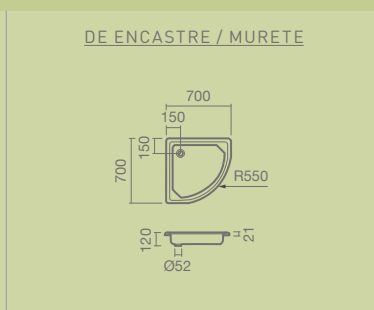
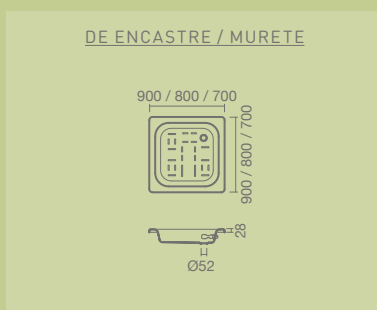

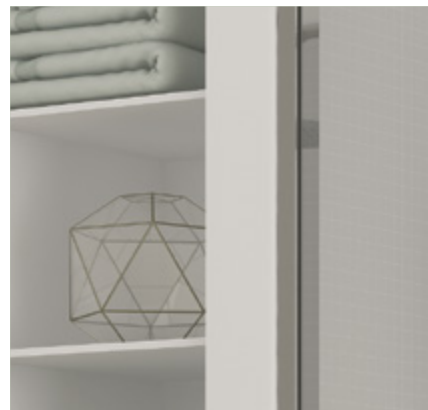

ESTÉTICA E FUNÇÃO

Com um desenho contemporâneo e funcional, as divisórias Sanitana respeitam todas as exigências estéticas atuais, minimizando o uso de perfis. São soluções práticas e versáteis, que obedecem aos mais altos padrões de qualidade.



DIVISÓRIAS

VERSATILIDADE

As dimensões e formatos das divisórias foram pensados para garantir a máxima compatibilidade com os nossos modelos de bases e banheiras. Para isso introduzimos perfis de compensação que permitem ajustar a instalação da divisória em função da base ou banheira escolhida ou já instalada.

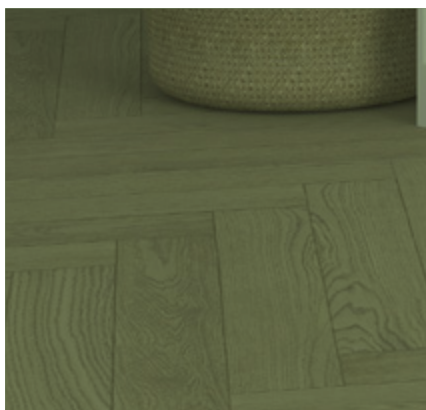

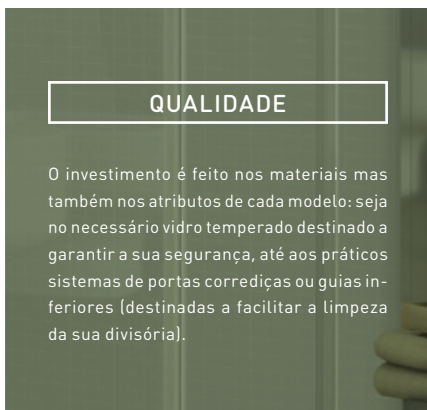
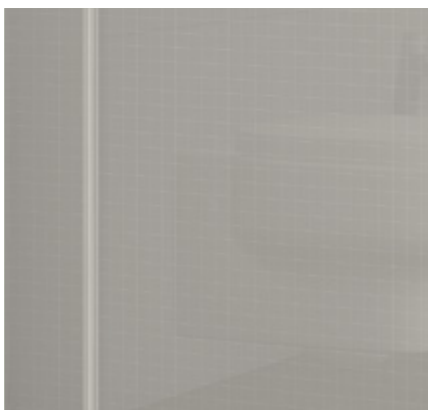
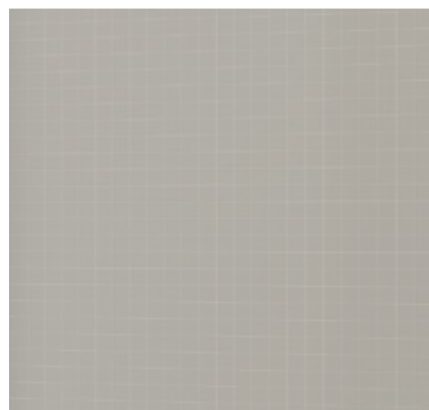
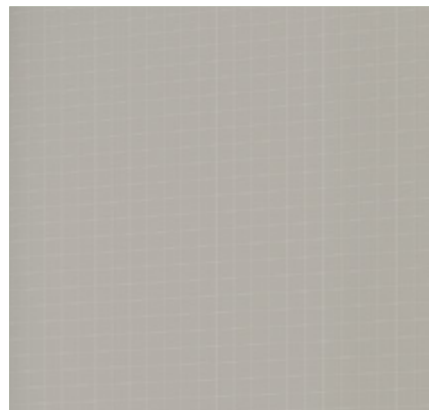

EVOLVE

PARA BASES DE CHUVEIRO

+ EVOLVE

APLICAÇÕES:

De canto / Entre-paredes

CARACTERÍSTICAS:

Reversível

Altura de 1950mm

Vidros temperados de 6mm com acabamento 'MaxiClean' para evitar a acumulação de calcário

Disponível em 3 versões:

2 vidros fixos + 2 vidros corrediços (2L2 + 2L2)

2 vidros fixos + 1 vidro corrediço (L2E + LF)

1 vidro fixo + vidro corrediço (L2E)

Grande oferta de medidas: de 700 x 700mm (versão 2L2 + 2L2) até 1600 x 900mm (L2E + LF)

Design minimalista com rolamentos integrados nos perfis

Sistema de portas corrediças por suspensão, sem guias inferiores

Sistema integrado de compensação até 100mm (na versão entre-paredes - L2E)

Permite dois tipos de instalação: com parafusos ou adesivos

Instalação simples

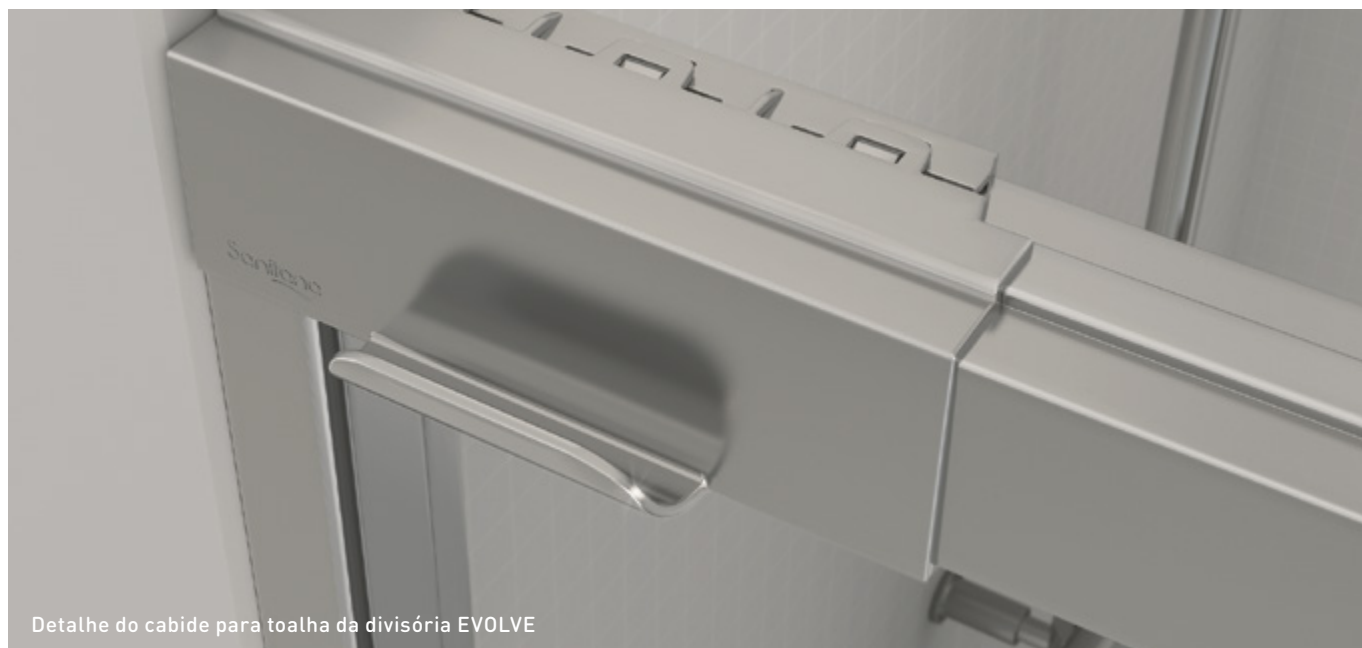

Detalhe do cabide para toalha da divisória EVOLVE



Divisória EVOLVE - versão L2E + LF - aplicada sobre base de duche ROCKS e torneira COSMO termostática com duche superior

+ EVOLVE Modelos e medidas

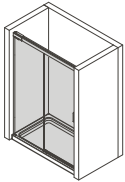
<p>MODELO L2E Entre-paredes Reversível</p>		1000
		1100
		1200
		1300
		1400
		1500
		1600

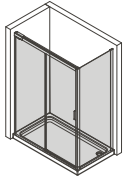
<p>MODELO L2E + LF De canto Reversível</p>		1000 x 700	1000 x 800	1000 x 900
		1100 x 700	1100 x 800	1100 x 900
		1200 x 700	1200 x 800	1200 x 900
		1300 x 700	1300 x 800	1300 x 900
		1400 x 700	1400 x 800	1400 x 900
		1500 x 700	1500 x 800	1500 x 900
		1600 x 700	1600 x 800	1600 x 900

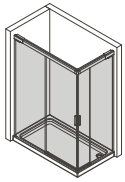
<p>MODELO 2L2 + 2L2 De canto Reversível</p>		700 x 700	700 x 750	700 x 800	700 x 850	700 x 900	700 x 1000	700 x 1100	700 x 1200
			750 x 750	750 x 800	750 x 850	750 x 900	750 x 1000	750 x 1100	750 x 1200
				800 x 800	800 x 850	800 x 900	800 x 1000	800 x 1100	800 x 1200
					850 x 850	850 x 900	850 x 1000	850 x 1100	850 x 1200
						900 x 900	900 x 1000	900 x 1100	900 x 1200
							1000 x 1000	1000 x 1100	1000 x 1200
								1100 x 1100	1100 x 1200
									1200 x 1200



Libertação de painéis para fácil limpeza - fechado



Libertação de painéis para fácil limpeza - aberto



Cabide para toalha

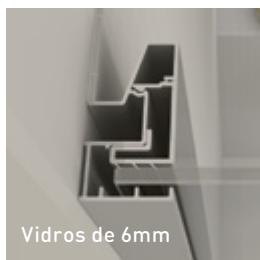

Vidros de 6mm



Corrediças ocultas



Vedante translúcido



Puxadores mínimos



DIVISÓRIAS

Divisória EVOLVE versão 2L2 + 2L2 aplicada sobre base de duche ROCKS e torneira COSMO



Detalhes dos perfis e estruturas de compensação da divisória EVOLVE



Divisória EVOLVE versão L2E aplicada sobre base de duche ROCKS e torneiras COSMO termostáticas com duche superior

OPEN

PARA BASES DE CHUVEIRO

+ OPEN

APLICAÇÕES:

De canto / Entre-paredes

CARACTERÍSTICAS:

Reversível

Altura de 1950mm

Vidros temperados de 8mm

Perfis minimalistas em latão cromado

Versão completa compatível com bases de chuveiro retangulares a partir de 1300mm



Perfis minimalistas



Vidros de 8mm



Vedante translúcido



Divisória walk-in OPEN em versão com painel frontal + lateral com base AXIS rectangular

+ OPEN Modelos

Painel Frontal

Painel Frontal + Porta

Painel Frontal + Lateral

Painel Frontal + Lateral + Porta

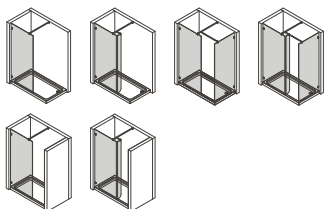

+ OPEN Medidas

Painel Frontal

Aplicação de canto:

1000/1100/1200/1300/1400/1500/1600/1700/1800 x 700/750/800/900mm

Aplicação entre-paredes:

1300/1400/1500/1600/1700/1800 x 700/750/800/900mm

Painel Frontal + Porta

Aplicação de canto:

1000/1100/1200/1300/1400/1500/1600/1700/1800 x 700/750/800/900mm

Aplicação entre-paredes:

1300/1400/1500/1600/1700/1800 x 700/750/800/900mm

Painel Frontal + Painel Lateral / Painel Frontal + Painel Lateral + Porta

Aplicação de canto:

1300/1400/1500/1600/1700/1800 x 700/750/800/900mm



DIVISÓRIAS

Divisória walk-in OPEN em versão com painel frontal + lateral + porta com base AXIS rectangular e chuveiro superior BLOC

+ VISION

APLICAÇÕES:

De canto / Entre-paredes

CARACTERÍSTICAS:

Altura de 1900mm

Vidros temperados de 8mm

Estrutura em aço inox com tratamento PVD

Sistema de portas corrediças por suspensão

Equipada com perfis e fechos magnéticos

Ajustável à medida até 50 mm em obra



Detalhe da união de portas da divisória VISION rectangular

VISION

PARA BASES DE CHUVEIRO



Sistema corrediço



Estanqueidade total



Estrutura minimal

+ VISION Medidas

Rectangular

Painéis frontais:
1200/1400/1500/1600/
1700/1800/1900mm

Painéis laterais:
700/750/800/900mm

Entre-paredes

Painéis frontais:
1200/1400/1500/1600/1700/
1750/1800/1850/1900mm

+ VISION Modelos

Rectangular (*reversível*)

Entre-paredes (*reversível*)

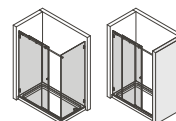



Divisória VISION Rectangular



Divisória STEP Entre-paredes com uma porta

STEP

PARA BASES DE CHUVEIRO



Divisória STEP Rectangular



Fácil manutenção



Ajustável à medida

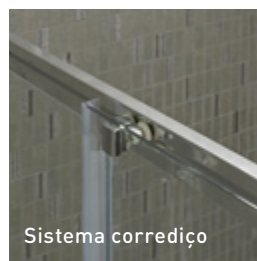

Sistema corredeço

+ STEP Modelos

Angular
Quadrada
Rectangular (*reversível*)
Entre-paredes (*reversível*)

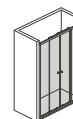
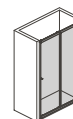

+ STEP

APLICAÇÕES:

De canto / Entre-paredes

CARACTERÍSTICAS:

Altura de 1950mm

Sistema corredeço leve e silencioso em teflon

Sistema integrado de compensação até 25mm
(50mm nos modelos *entre-paredes*)

Guias inferiores suspensas para facilitar a limpeza

Compatível com todas as bases de chuveiro Sanitana

Vidros temperados de 6mm

Puxadores cromados

Estanqueidade total

Instalação simples

Reversível

+ STEP Medidas

Angular

800 x 800/900 x 900/1000 x 1000mm

Quadrada

700 x 700/800 x 800/900 x 900/1000 x 1000mm

Rectangular (*reversível*)

900 x 720/750mm

1000/1200/1400/1600/1700 x 700mm

1000/1100/1200/1300/1400/1500/1600/1700/1800 x 800mm

Entre-paredes (*reversível*)

1000/1100/1200/1300/1400/1500/1600/1700/1800mm

STEP

PARA BANHEIRAS



Divisória STEP para banheira com painel simples pivotante

+ STEP

CARACTERÍSTICAS:

Sistema integrado de compensação

Perfil em alumínio cromado

Vidros temperados de 6mm

Abertura rebatível a 180°

+ STEP Modelos e Medidas

Divisória de painel simples (reversível)

900 x 1500mm

Divisória de painel duplo (reversível)

1200 x 1500mm



Divisória STEP com painel duplo (1 fixo e 1 pivotante) com torneira BALANCE para banheira

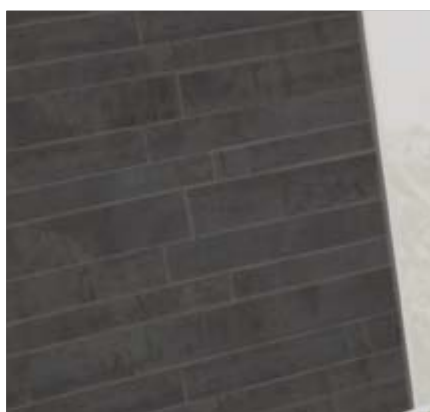
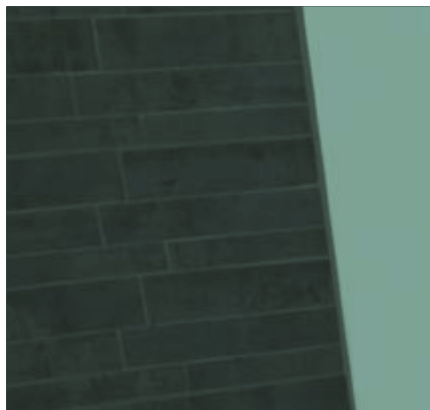

COLUNAS

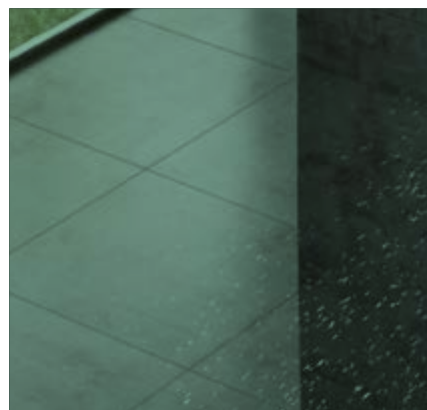
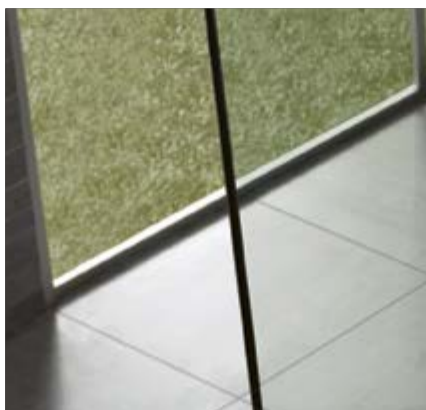
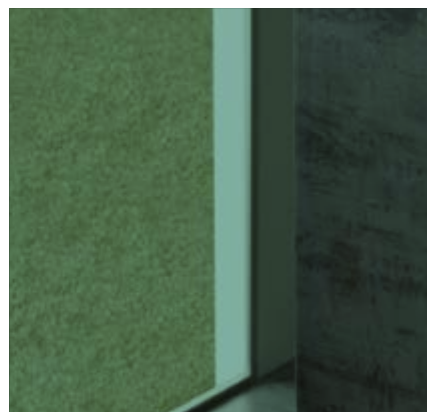

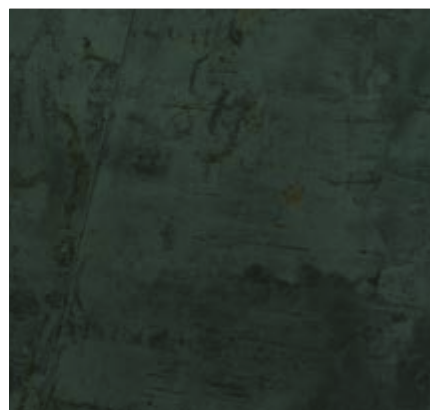

QUALIDADE

Nos materiais e nas funções. Seja com injetores pulverizantes que simulam um banho turco, ou pulsantes que lhe proporcionam uma massagem intensa; aos práticos chuveiros de grandes dimensões, cascatas e ainda misturadoras termostáticas, que regulam com precisão a temperatura da água.

VANTAGENS

As colunas de hidromassagem são uma solução funcional e versátil para equipar a sua casa de banho. Podem ser aplicadas mesmo nos espaços mais reduzidos e respondem eficazmente a todas as exigências do dia-a-dia. Dê ao seu espaço de banho uma identidade atual e contemporânea.

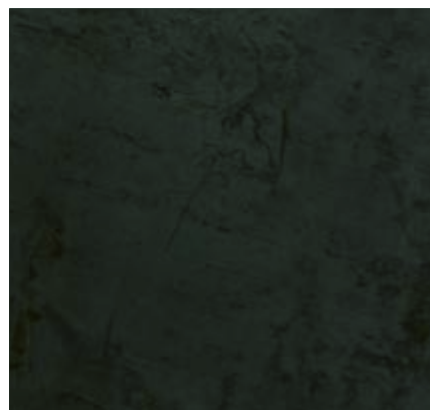



Coluna de hidromassagem SLIM

SLIM

COLUNA DE HIDROMASSAGEM



+ SLIM

MEDIDAS:

1655 x 260 x 603mm

CARACTERÍSTICAS:

Para aplicação com base de chuveiro

Chuveiro superior de grandes dimensões

3 Injetores de massagem orientáveis de tripla função:

efeito *chuva*, *pulsante* e *pulverização*

Chuveiro de mão incluído

Selector de 4 funções

Misturadora termostática

Estante porta-objects integrada

Estrutura em solid surface (HI-MACS® da LG)

Medidas de ligação à rede: 150mm entre eixos (máximo)



COLUNAS

Lavatório ARENA 70 com torneira UNIC de cano alto, base de chuveiro ROCKS e coluna de hidromassagem SLIM



Chuveiro superior

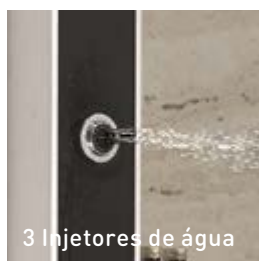

3 Injetores de água



Coluna termostática

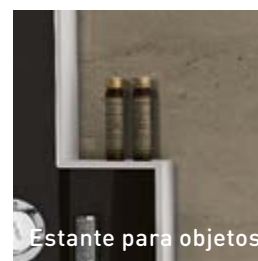

Estante para objetos

EDGE

COLUNA DE HIDROMASSAGEM

+ EDGE

MEDIDAS:

1625 x 220 x 365mm

CARACTERÍSTICAS:

Para aplicação com base de chuveiro
Chuveiro superior de grandes dimensões

6 injectores de massagem dupla:

efeito *chuva* e *pulverização*

Chuveiro de mão incluído

Cascata de água

Selector de 5 funções

Misturadora termostática

Vidro temperado de 6mm

Estrutura em aço inox

Medidas de ligação à rede standard

Disponível em 2 versões (*Black* e *Float*)



Cascata de água da coluna EDGE Float

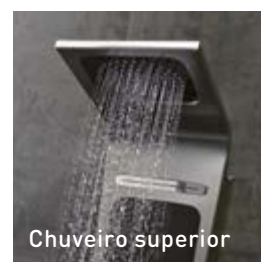

Chuveiro superior



6 Injectores de água

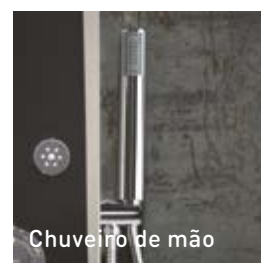

Chuveiro de mão



Coluna termostática



COLUNAS

Coluna de hidromassagem EDGE Black com base de chuveiro VITA

YN BLACK

COLUNA DE HIDROMASSAGEM



Coluna de hidromassagem YN BLACK

+ YN BLACK

MEDIDAS: 1480 x 230 x 480mm

CARACTERÍSTICAS:

- Para aplicação com base de chuveiro ou banheira
- 6 Injectores de massagem orientáveis: efeito *pulsante*
- Chuveiro superior de grandes dimensões orientável
- Chuveiro de mão incluído
- Misturadora termostática
- Selector de 5 funções
- Saída de água inferior
- Painel em aço inox
- Medidas de ligação à rede standard





Coluna de hidromassagem YN BLACK

YN

COLUNA DE HIDROMASSAGEM

+ YN BLACK

MEDIDAS: 1480 x 230 x 480mm

CARACTERÍSTICAS:

- Para aplicação com base de chuveiro ou banheira
- 6 Injectores de massagem orientáveis: efeito *pulsante*
- Chuveiro superior de grandes dimensões orientável
- Chuveiro de mão incluído
- Misturadora termostática
- Selector de 5 funções
- Saída de água inferior
- Painel em aço inox
- Medidas de ligação à rede standard



Coluna de hidromassagem YN



Coluna de hidromassagem YN com base de chuveiro VITA

BEAT

COLUNA DE DUCHE

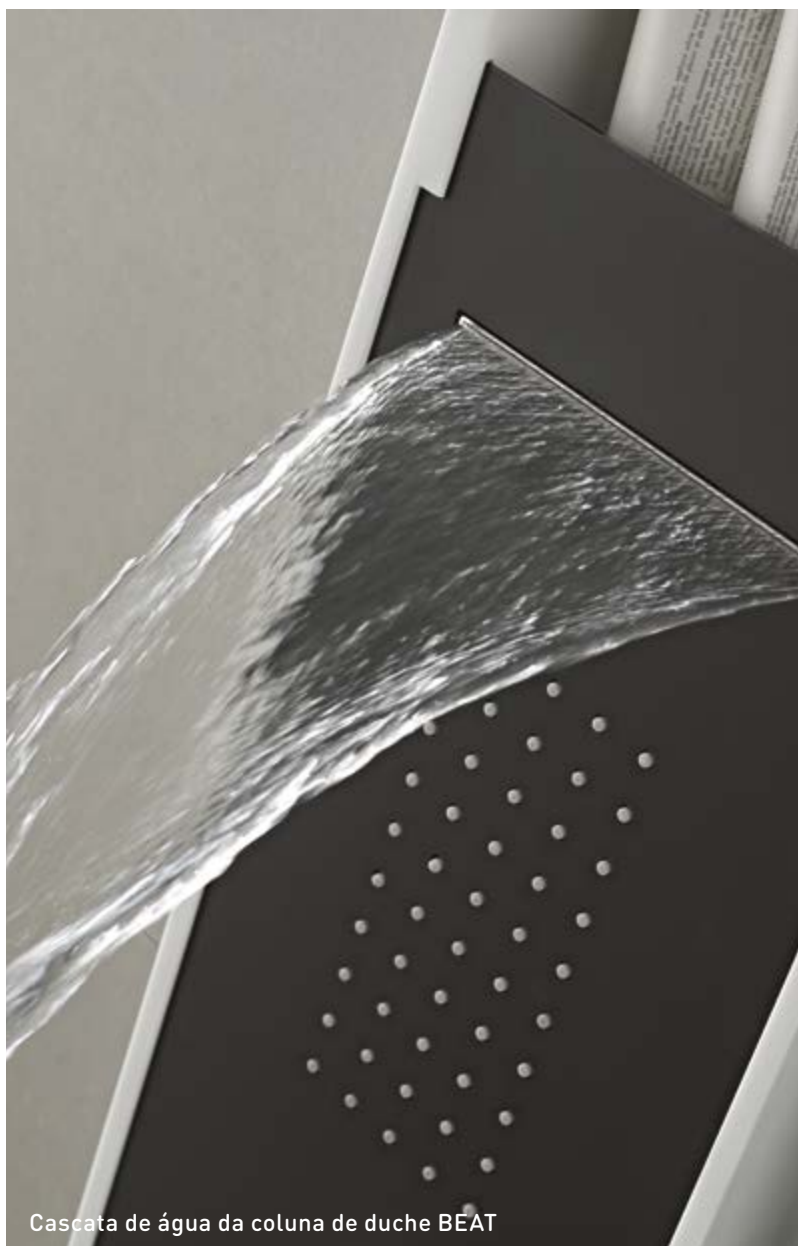

Cascata de água da coluna de duche BEAT



2 Injectores XL



Chuveiro de mão

+ BEAT

MEDIDAS:

1355 x 220 x 425mm

CARACTERÍSTICAS:

Para aplicação com base de chuveiro

2 Injectores de massagem XL: efeito *chuva*

Chuveiro superior de grandes dimensões

Chuveiro de mão incluído

Cascata de água

Selector de 5 funções

Misturadora monocomando

Estrutura em solid surface (HI-MACS® da LG)

Medidas de ligação à rede standard





Coluna de duche BEAT



Cascata de água da coluna de duche ACQUA Branca

ACQUA

COLUNA DE DUCHE



Coluna de duche ACQUA Preta

+ ACQUA

MEDIDAS:

1500 x 220 x 400mm

CARACTERÍSTICAS:

- Para aplicação com base de chuveiro
- 2 injectores de massagem XL: efeito *chuva*
- Chuveiro superior de grandes dimensões
- Chuveiro de mão incluído
- Cascata de água
- Selector de 5 funções
- Misturadora monocomando
- Estrutura em aço inox
- Medidas de ligação à rede standard
- Disponível em 2 versões (*Preta e Branca*)



Chuveiro superior



Chuveiro de mão



2 Injectores XL

FLEX

COLUNA DE HIDROMASSAGEM

+ FLEX

MEDIDAS:

1500 x 210 x 455mm

CARACTERÍSTICAS:

Para aplicação com base de chuveiro

3 Injectores de massagem orientáveis de tripla função:

efeito *chuva*, *pulsante* e *pulverização*

Chuveiro superior de grandes dimensões

Misturadora monocomando

Seletor de 4 funções

Chuveiro de mão incluído

Medidas de ligação à rede standard

Casco em dibond disponível em:

Branco, Preto, Prata Escovada e Wengué

1 FLEX Square

CARACTERÍSTICAS:

Chuveiro superior e chuveiro de mão com:

formato quadrado



2 FLEX Round

CARACTERÍSTICAS:

Chuveiro superior e chuveiro de mão com:

formato redondo



Coluna de hidromassagem FLEX SQUARE em preto



Coluna de hidromassagem FLEX SQUARE em wengué



Coluna de hidromassagem FLEX ROUND em branco



Coluna de hidromassagem FLEX ROUND em prata escovada

LOOK

COLUNA DE HIDROMASSAGEM

+ LOOK

MEDIDAS:

1500 x 270 x 485mm

CARACTERÍSTICAS:

Para aplicação com base de chuveiro ou banheira

6 Injectores de massagem: efeito *pulsante*

Chuveiro superior de grandes dimensões

Chuveiro de mão incluído

Saída de água inferior

Selector de 5 funções

Misturadora termostática

Estrutura em Baydur® lacado em alto brilho

Medida de ligação à rede standard

Disponível em 2 versões:

Prata e Preto



Coluna de hidromassagem LOOK Preto

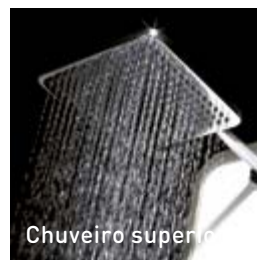



Coluna de hidromassagem LOOK Prata

MODELOS E ATRIBUTOS

COLUNAS DE HIDROMASSAGEM E DUCHE / GUIA RÁPIDO



SLIM
Pág. 222



EDGE
Pág. 224



YN BLACK
Pág. 226

INJECTORES DE HIDROMASSAGEM

Nº DE INJETORES 1 Função (<i>chuva</i>)			
Nº DE INJETORES 1 Função (<i>pulsante</i>)			6
Nº DE INJETORES 2 Funções (<i>chuva e pulverização</i>)		6	
Nº DE INJETORES 3 Funções (<i>chuva, pulsante e pulverização</i>)	3		
INJETORES DE ÁGUA Orientáveis	•		•

CONTROLO DE HIDROMASSAGEM

Nº DE FUNÇÕES Selector de funções de hidromassagem	4	5	5
MISTURADORA Monocomando			
MISTURADORA Termostática	•	•	•

SAÍDAS DE ÁGUA

CHUVEIRO Superior de grandes dimensões	•	•	•
CHUVEIRO De mão	•	•	•
CASCATA De água		•	
SAÍDA DE ÁGUA Inferior			•

CARACTERÍSTICAS EXTRA E MATERIAIS

ESTANTE Porta-objectos	•		
BARRA DE DUCHE Deslizante			
MEDIDAS DE LIGAÇÃO À REDE Standard		•	•
CASCO Dibond®			
CASCO Baydur® lacado com acabamento brilho			
ESTRUTURA Aço inox		•	•
ESTRUTURA Solid surface (HI-MACS® da LG)	•		



YN
Pág. 228



BEAT
Pág. 230



ACQUA
Pág. 232



FLEX
Pág. 234



LOOK
Pág. 236

	2 (XL)	2 (XL)		
6				6
			3	
•			•	•
5	5	5	4	5
	•	•	•	
•				•
•	•	•	•	•
•	•	•	•	•
	•			
	•			
•	•	•	•	•
			•	
				•
•		•		
	•			

MODELOS E MEDIDAS

COLUNAS DE HIDROMASSAGEM E DUCHE / GUIA RÁPIDO E DESENHOS TÉCNICOS

SLIM

Página 222

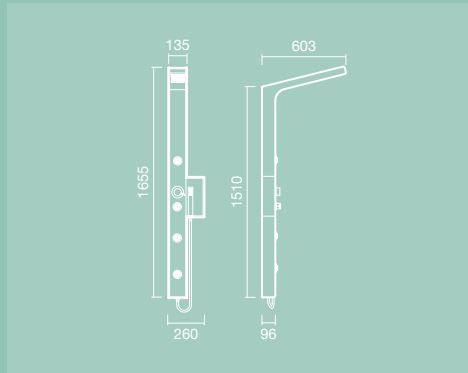

EDGE

Página 224

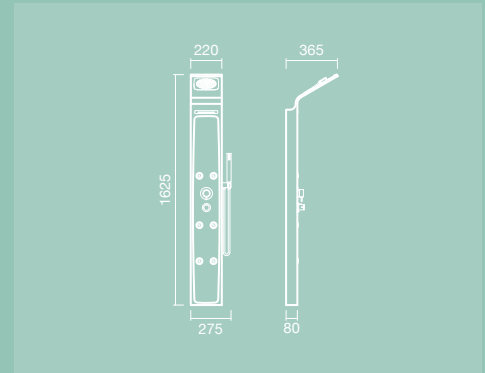

YN BLACK

Página 226

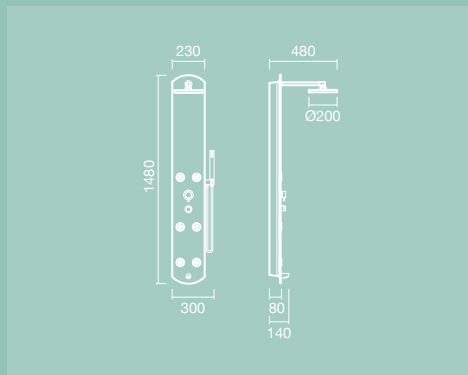

YN

Página 228

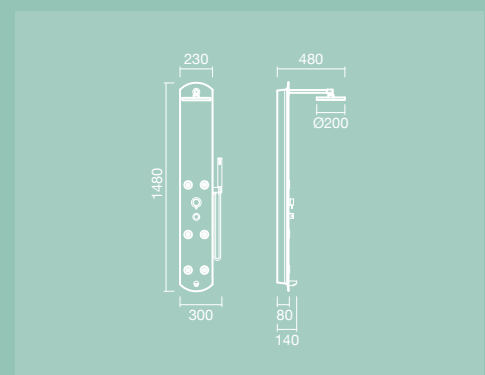

BEAT

Página 230

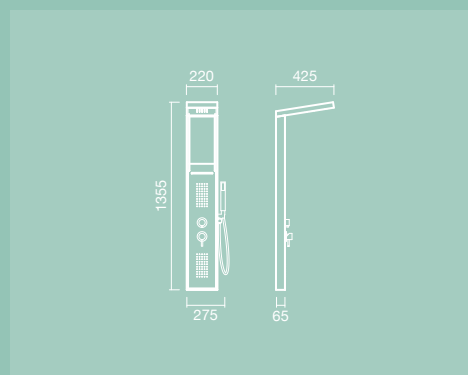

ACQUA

Página 232

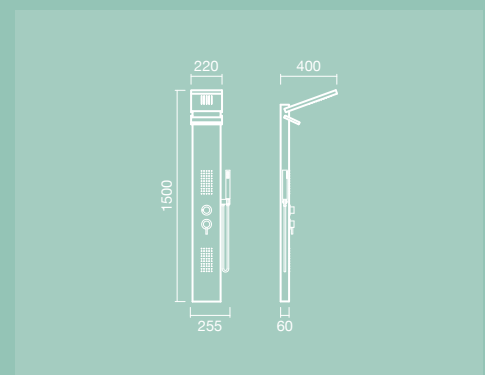

FLEX Round

Página 234

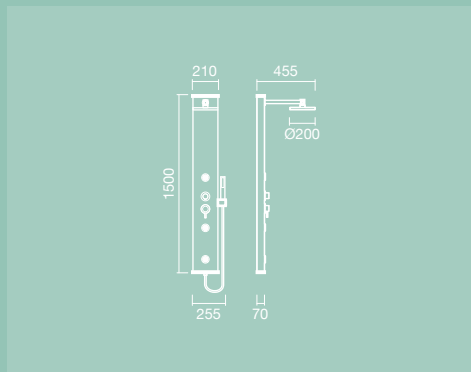

FLEX Square

Página 234

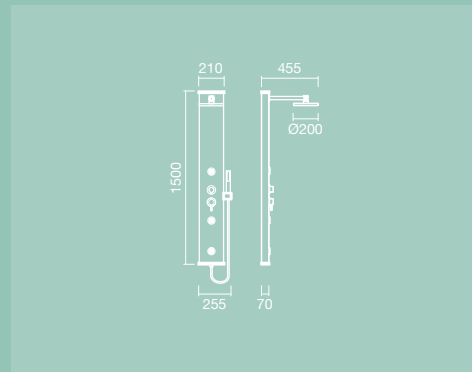

LOOK

Página 236

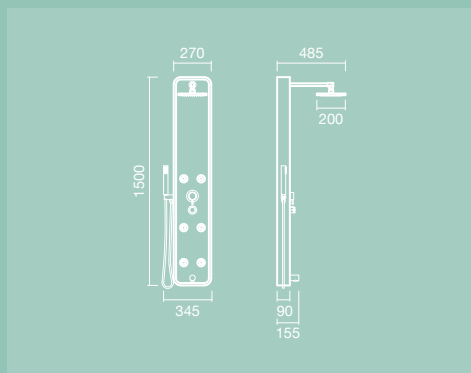

O SEU REFÚGIO

Agora pode desfrutar da derradeira experiência de bem-estar no conforto da sua casa de banho. Modernas e elegantes, as nossas banheiras marcam pela sua comodidade e funcionalidade, proporcionando-lhe um espaço de evasão e relaxamento.



BANHEIRAS





HIDROMASSAGEM

Poderá ainda usufruir igualmente dos benefícios da hidromassagem que, através de diferentes tipos de injetores, permitirá-lhe-á desfrutar do poder relaxante e tonificante da água, numa experiência de banho verdadeiramente envolvente.

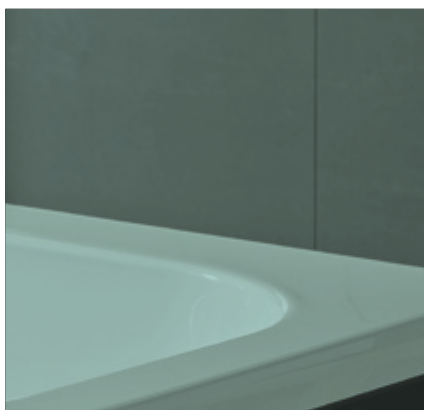

GARANTIA

As nossas banheiras dispõem de uma garantia de 5 anos (3 anos para componentes e 5 anos para serviço técnico pós-venda), dispondo para tal de um serviço de assistência técnica especializado, que abrange todo o território nacional.



QUALIDADE

Sem exceção, todas as nossas banheiras são submetidas a testes rigorosos e ensaios de qualidade que garantem a segurança elétrica e o seu bom funcionamento, permitindo a sua certificação por uma entidade creditada.



CUBIC

ACRÍLICA

+ CUBIC

MEDIDAS:

1800 / 1700 / 1600 x 800mm

1700 / 1600 x 750mm

1700 / 1600 / 1500 / 1400 x 700mm

CAPACIDADE:

265 / 224 / 211 / 206 / 201 / 186 / 172 / 164 / 143mm

SISTEMAS DE HIDROMASSAGEM:

HID Digital

HID Dorsal

Multijet Digital

Multijet Dorsal

Jet Set Star Basic e Top

Jet Set Star Dorsal Basic e Top

CARACTERÍSTICAS:

Pés de apoio, estrutura em aço zincado e painéis próprios (requerem o uso de estrutura) disponíveis



Banheira de hidromassagem CUBIC Jet Set Star Dorsal Top com torneira BALANCE

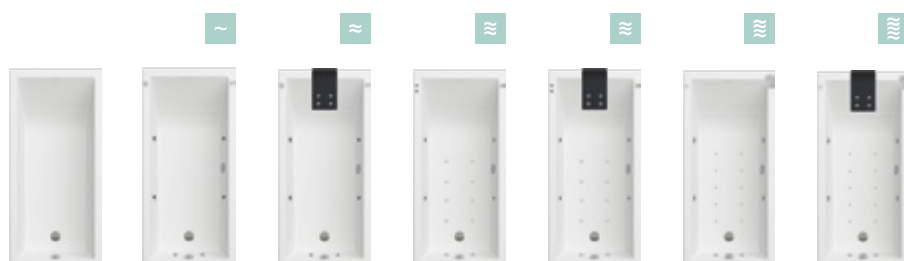



Banheira de hidromassagem CUBIC Jet Set Star Dorsal Top com painéis em preto brilho e torneira SELEKT

CAROLINA

ACRÍLICA



+ CAROLINA

MEDIDAS:

1700 x 800mm

CAPACIDADE:

221 litros

SISTEMAS DE HIDROMASSAGEM:

HID Digital (antiderrapante: OPCIONAL)

HID Dorsal (antiderrapante: OPCIONAL)

Multijet Digital

Multijet Dorsal

Jet Set Star Basic e Top

Jet Set Star Dorsal Basic e Top

CARACTERÍSTICAS:

Pés de apoio, estrutura em aço zincado e painéis disponíveis

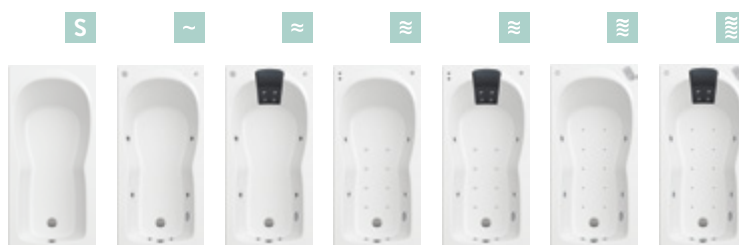

+ QUATTRO

MEDIDAS:

1800 x 1000mm

CAPACIDADE:

270 litros

SISTEMAS DE HIDROMASSAGEM:

HID Digital

HID Dorsal

Multijet Digital

Multijet Dorsal

Jet Set Star Basic e Top

Jet Set Star Dorsal Basic e Top

CARACTERÍSTICAS:

Pés de apoio, estrutura em aço zincado e painéis disponíveis



QUATTRO

ACRÍLICA

BANHEIRAS

Banheira de hidromassagem QUATTRO Jet Set Star Dorsal Top

PLAZA

ACRÍLICA

+ PLAZA

MEDIDAS:

1800 / 1700 x 800mm

CAPACIDADE:

287 / 264 litros

SISTEMAS DE HIDROMASSAGEM:

HID Digital

HID Dorsal

Multijet Digital

Multijet Dorsal

Jet Set Star Basic e Top

Jet Set Star Dorsal Basic e Top

CARACTERÍSTICAS:

Pés de apoio, estrutura em aço
zincado e painéis disponíveis



Banheira PLAZA com torneira FLOW para banheira

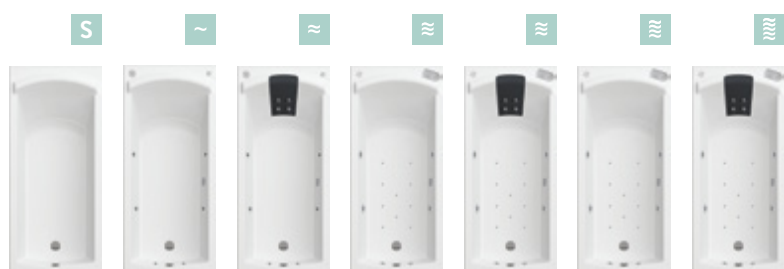

VITA

ACRÍLICA



Banheira de hidromassagem VITA Jet Set Star Dorsal

+ VITA

MEDIDAS:

1900 x 900 / 1800 x 900 / 1800 x 800mm

CAPACIDADE:

328 / 305 / 262 litros

SISTEMAS DE HIDROMASSAGEM:

HID Digital

HID Dorsal

Multijet Digital

Multijet Dorsal

Jet Set Star Basic e Top

Jet Set Star Dorsal Basic e Top

CARACTERÍSTICAS:

Pés de apoio, estrutura em aço zincado e painéis frontais, de topo e em "L" disponíveis

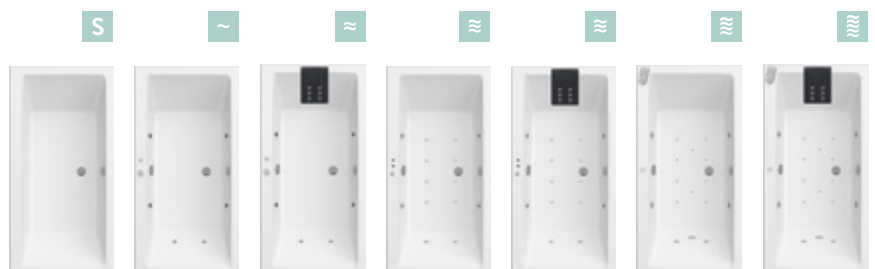



Banheira PACIFIC

+ PACIFIC

MEDIDAS:

1700 / 1600 x 750mm

1700 / 1600 / 1500 / 1400 x 700mm

CAPACIDADE:

191 / 182 / 180 / 172 / 150 / 139 litros

CARACTERÍSTICAS:

Pés de apoio, estrutura em aço zincado e painéis disponíveis

S



PACIFIC

ACRÍLICA

NEXO

ACRÍLICA

+ NEXO

MEDIDAS:

1700 / 1600 x 800mm
 1700 / 1600 / 1500 x 750mm
 1700 / 1600 / 1500 / 1400 x 700mm

CAPACIDADE:

239 / 225 / 212 / 210 / 176 / 211 / 190 / 167 / 145 litros

SISTEMAS DE HIDROMASSAGEM:

HID Digital
 HID Dorsal
 Multijet Digital
 Multijet Dorsal
 Jet Set Star Basic e Top
 Jet Set Star Dorsal Basic e Top

CARACTERÍSTICAS:

Pés de apoio, estrutura em aço zincado e painéis disponíveis



Banheira de hidromassagem NEXO Jet Set Star Dorsal Top e torneira BALANCE de pé alto para banheira

BANHEIRAS





Banheira de hidromassagem RAQUEL HID Dorsal com torneira NOA para banheira

RAQUEL

ACRÍLICA

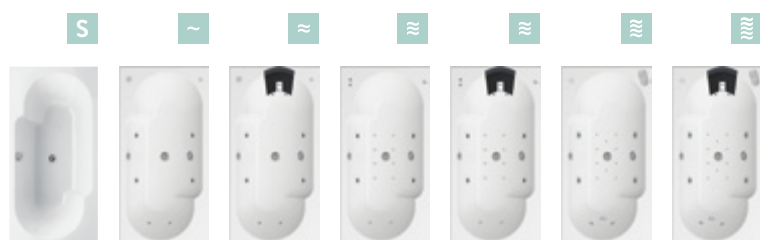

+ RAQUEL

MEDIDAS:

1800 x 900mm

CAPACIDADE:

297 litros

SISTEMAS DE HIDROMASSAGEM:

HID Digital
HID Dorsal
Multijet Digital
Multijet Dorsal
Jet Set Star Basic e Top
Jet Set Star Dorsal Basic e Top

CARACTERÍSTICAS:

Pés de apoio, estrutura em aço
zincado e painéis disponíveis

PATRÍCIA

ACRÍLICA

+ PATRÍCIA

MEDIDAS:

1850 x 1050mm

CAPACIDADE:

284 litros

SISTEMAS DE HIDROMASSAGEM:

HID Dorsal (antiderrapante: OPCIONAL)

Multijet Digital

Multijet Dorsal

Jet Set Star Basic e Top

Jet Set Star Dorsal Basic e Top

CARACTERÍSTICAS:

Pés de apoio, estrutura em aço zincado e painéis disponíveis



Banheira de hidromassagem PATRÍCIA Jet Set Star Dorsal

BANHEIRAS

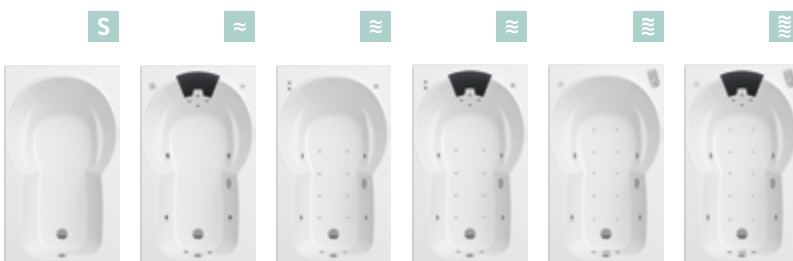



Banheira de hidromassagem HELENA Jet Set Star Dorsal com torneira NOA para banheira

HELENA

ACRÍLICA

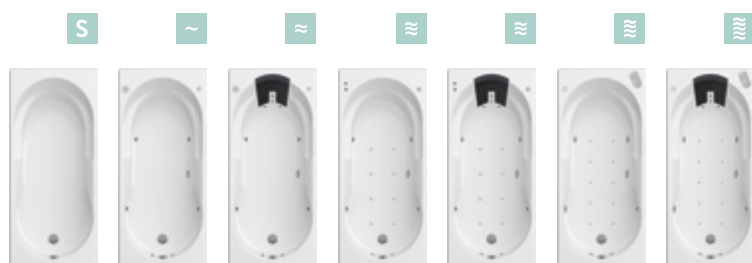

+ HELENA

MEDIDAS:

1700 / 1600 x 750mm

1700 / 1600 / 1500 x 700mm

CAPACIDADE:

191 / 176 / 180 / 160 / 144 litros

SISTEMAS DE HIDROMASSAGEM:

HID Digital (antiderrapante: OPCIONAL)

HID Dorsal (antiderrapante: OPCIONAL)

Multijet Digital

Multijet Dorsal

Jet Set Star Basic e Top

Jet Set Star Dorsal Basic e Top

CARACTERÍSTICAS:

Pés de apoio, estrutura em aço zincado e painéis disponíveis

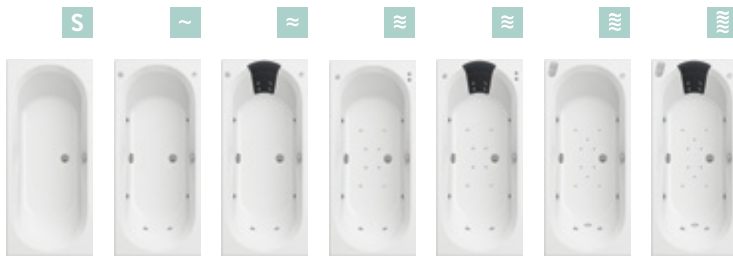

ROSÁRIO

ACRÍLICA

+ ROSÁRIO

MEDIDAS:

1800 x 800mm

CAPACIDADE:

232 litros

SISTEMAS DE HIDROMASSAGEM:

HID Digital

HID Dorsal

Multijet Digital

Multijet Dorsal

Jet Set Star Basic e Top

Jet Set Star Dorsal Basic e Top

CARACTERÍSTICAS:

Pés de apoio, estrutura em aço zincado e painéis disponíveis



Banheira de hidromassagem ROSÁRIO Jet Set Star Dorsal com torneira BLOC para banheira

SARA

ACRÍLICA

+ SARA

MEDIDAS:

1800 x 900mm

CAPACIDADE:

233 litros

SISTEMAS DE HIDROMASSAGEM:

HID Digital

HID Dorsal

Multijet Digital

Multijet Dorsal

Jet Set Star Basic e Top

Jet Set Star Dorsal Basic e Top

CARACTERÍSTICAS:

Pés de apoio disponíveis



Banheira SARA com torneira BALANCE de pé alto para banheira e louça sanitária CORAL





Banheira NEXO assimétrica Multijet Dorsal com painéis em wengué e torneira UNIC

NEXO

ACRÍLICA

+ NEXO

MEDIDAS:
1600 x 1000 (ESQ) / 1600 x 1000mm (DIR)

CAPACIDADE:
240 litros

SISTEMAS DE HIDROMASSAGEM:

HID Digital
HID Dorsal
Multijet Digital
Multijet Dorsal

CARACTERÍSTICAS:

Pés de apoio, estrutura em aço zincado e painéis em branco e wengué disponíveis

MARGARIDA

ACRÍLICA

+ MARGARIDA

MEDIDAS:

1450 x 1450mm

CAPACIDADE:

234 litros

SISTEMAS DE HIDROMASSAGEM:

HID Digital

HID Dorsal

Multijet Digital

Multijet Dorsal

Jet Set Star Basic e Top

Jet Set Star Dorsal Basic e Top

CARACTERÍSTICAS:

Estrutura de apoio incluída

Painel angular disponível



Banheira MARGARIDA com painel angular próprio e torneira termostática BALANCE para banheira

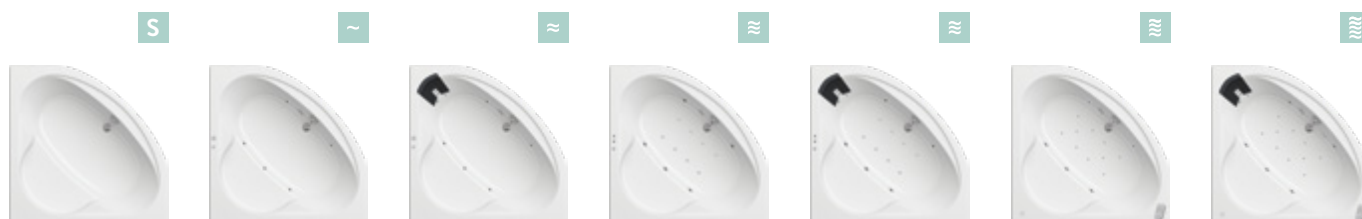



Banheira CLÁUDIA com painel angular próprio e torneira termostática BALANCE para banheira

CLÁUDIA

ACRÍLICA

+ CLÁUDIA

MEDIDAS:

1400 x 1400mm

CAPACIDADE:

276 litros

SISTEMAS DE HIDROMASSAGEM:

HID Digital

HID Dorsal

Multijet Digital

Multijet Dorsal

Jet Set Star Basic e Top

Jet Set Star Dorsal Basic e Top

CARACTERÍSTICAS:

Estrutura de apoio incluída

Painel angular disponível

TREVO

ACRÍLICA



Banheira TREVO com painel angular próprio e torneira FLOW para banheira

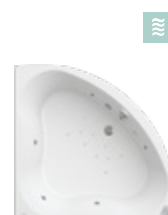

+ TREVO

MEDIDAS:

1350 x 1350mm

CAPACIDADE:

268 litros

SISTEMAS DE HIDROMASSAGEM:

HID Digital

HID Dorsal

Multijet Digital

Multijet Dorsal

Jet Set Star Basic e Top

Jet Set Star Dorsal Basic e Top

CARACTERÍSTICAS:

Estrutura de apoio incluída

Painel angular disponível



Banheira OÁSIS com painel angular próprio

OÁSIS

ACRÍLICA

+ OÁSIS

MEDIDAS:
1300 x 1300mm

CAPACIDADE:
201 litros

SISTEMAS DE HIDROMASSAGEM:

HID Digital

Multijet Digital

Jet Set Star Basic e Top

CARACTERÍSTICAS:

Estrutura de apoio incluída

Painel angular disponível

ÁREA

ACRÍLICA

+ ÁREA

MEDIDAS:

1400 x 1400mm

CAPACIDADE:

257 litros

SISTEMAS DE HIDROMASSAGEM:

HID Digital

HID Dorsal

Multijet Digital

Multijet Dorsal

Jet Set Star Basic e Top

Jet Set Star Dorsal Basic e Top

CARACTERÍSTICAS:

Estrutura de apoio incluída

Painel angular disponível



Banheira ÁREA Jet Set Star Dorsal Top com painel angular próprio e torneira FLOW para banheira

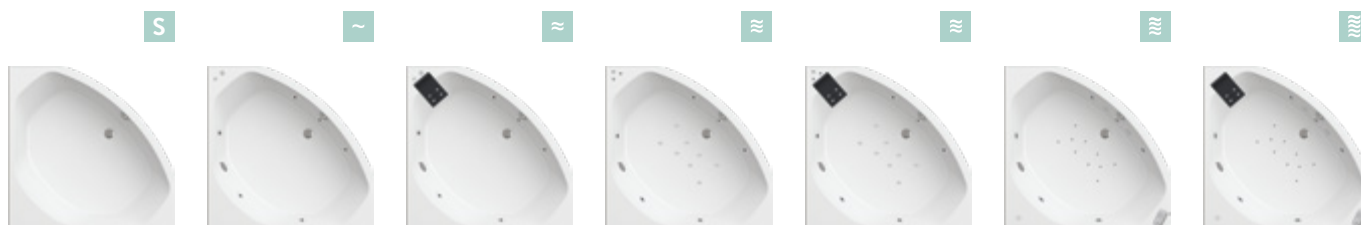

FÁTIMA

ACRÍLICA



Banheira FÁTIMA com painel angular próprio e torneira COSMO de encastre



S



r



m



m



m



m



m

+ FÁTIMA

MEDIDAS:

1505 x 1005 (ESQ) / 1505 x 1005mm (DIR)

CAPACIDADE:

210 litros

SISTEMAS DE HIDROMASSAGEM:

- HID Digital
- HID Dorsal
- Multijet Digital
- Multijet Dorsal
- Jet Set Star Basic e Top
- Jet Set Star Dorsal Basic e Top

CARACTERÍSTICAS:

- Pés de apoio incluídos
- Estrutura de aço zincado e painel angular disponíveis

+ RUTE

MEDIDAS:

1370 x 1370mm

CAPACIDADE:

260 litros

SISTEMAS DE HIDROMASSAGEM:

HID Digital

Multijet Digital

Jet Set Star Basic e Top

CARACTERÍSTICAS:

Estrutura de apoio incluída

Painel angular disponível



Banheira RUTE

RUTE

ACRÍLICA



Banheira ISABEL com painel angular próprio e torneira FLOW para banheira

ISABEL

ACRÍLICA

+ ISABEL

MEDIDAS:

1500 x 1500mm

CAPACIDADE:

327 litros

SISTEMAS DE HIDROMASSAGEM:

HID Digital

Multijet Digital

Jet Set Star Basic e Top

CARACTERÍSTICAS:

Estrutura de apoio incluída

Painel angular disponível

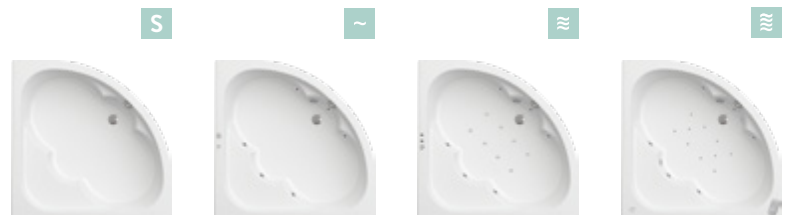

PAINÉIS

MADEIRA



Banheira NEXO com painéis em madeira na cor wengué e torneira BALANCE para banheira

APLICAÇÃO DE CANTO

Painel frontal + topo

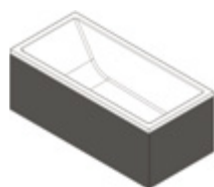

APLICAÇÃO ENTRE-PAREDES

Painel frontal

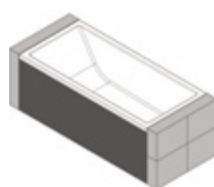

APLICAÇÃO STAND-ALONE

Painel frontal + topo stand-alone



	PAINEL FRONTAL 510mm de altura	PAINEL FRONTAL 560mm de altura	PAINEL TOPO 510mm de altura	PAINEL TOPO 560mm de altura	PAINEL STAND-ALONE 510mm de altura	PAINEL STAND-ALONE 560mm de altura
1800mm	•	•				
1700mm	•	•				
1600mm	•	•				
900mm			•	•	•	•
800mm			•	•	•	•
750mm			•	•	•	•
700mm			•	•	•	•

+ PAINÉIS Madeira

APLICAÇÃO: banheiras acrílicas de formato retangular

CORES: Preto Brilho / Carvalho / Wengué

CARACTERÍSTICAS:

9 mm de espessura

Leves e fáceis de manusear

Fabricados em madeira - durável e resistente à água e humidade

Sistema de montagem com kit de fixação dual-lock que permite acompanhar a aba da banheira



Detalhe dos painéis em madeira na cor carvalho



Preto Brilho

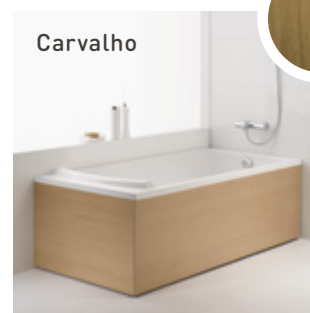

Carvalho



Wengué

+ QUEEN

MEDIDAS:

1800 x 800mm

CAPACIDADE:

230 litros

CARACTERÍSTICAS:

Em chapa de aço esmaltado

Kit de insonorização incluído

Disponível em 3 versões:

Drop in (encastre)

Free standing (com painel integral)

Woodline (*free standing* com pés)

1 QUEEN *Drop in*

CARACTERÍSTICAS:

Com ou sem antiderrapante

Kit de insonorização incluído

Pés de apoio e válvula de descarga fornecidos separadamente



2 QUEEN *Free standing*

CARACTERÍSTICAS:

Antiderrapante

Pronta a instalar

Kit de insonorização, painel integral "one piece" e válvula automática cromada incluídos



3 QUEEN *Woodline*

CARACTERÍSTICAS:

Antiderrapante

Estrutura de suporte *free-standing* lacada a preto

Válvula de descarga incluída





Banheira QUEEN com painel integral (aplicação *free standing*) e torneira COSMO de encaixe para banheira



EUROPA

AÇO ESMALTADO

Banheira EUROPA em aplicação de encastre

+ EUROPA

MEDIDAS:

1700 / 1600 / 1500 / 1400 / 1300 / 1200 x 700mm

CAPACIDADE:

190 / 180 / 170 / 160 / 150 / 140 litros

CARACTERÍSTICAS:

Casco com ou sem antiderrapante

Pés de apoio e válvula de descarga
fornecidos separadamente

+ EUROPA Infantil

MEDIDAS:

1050 x 700mm

CAPACIDADE:

110 litros

CARACTERÍSTICAS:

Com ou sem assento

Banheira sem assento com antiderrapante

Pés de apoio e válvula de descarga
fornecidos separadamente



Banheira EUROPA INFANTIL com assento em aplicação de encastre



Banheira HOTEL com torneira SILK para banheira

HOTEL

AÇO ESMALTADO

+ HOTEL

MEDIDAS:

1700 / 1600 / 1500 / 1400 x 750mm

CAPACIDADE:

180 / 170 / 160 / 150 litros

CARACTERÍSTICAS:

Com antiderrapante esmaltado

Pés de apoio e válvula de descarga fornecidos separadamente

MODELOS E INFORMAÇÃO

BANHEIRAS ACRÍLICAS / TECNOLOGIA E INFORMAÇÃO

SISTEMAS

FUNCIONALIDADES

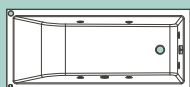

HID Digital

6 INJECTORES orientáveis de água
COMANDO digital
SENSOR eletrônico do nível de água

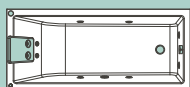

HID Dorsal

6 INJECTORES orientáveis de água
4 a 6 INJECTORES dorsais
APOIO de cabeça
COMANDO digital
SENSOR eletrônico do nível de água

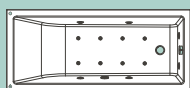

MULTIJET Digital

6 INJECTORES orientáveis e reguláveis de água
8 INJECTORES de ar (fundo)
CONTROLO digital
REGULADOR de caudal de água
SENSOR eletrônico do nível de água

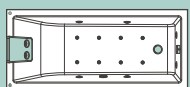

MULTIJET Dorsal

6 INJECTORES orientáveis e reguláveis de água
8 INJECTORES de ar (fundo)
4 a 6 INJECTORES dorsais
APOIO de cabeça
CONTROLO digital
REGULADOR de caudal de água
SENSOR eletrônico do nível de água

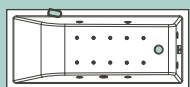

JET SET STAR

6 INJECTORES orientáveis e reguláveis de água
8 a 10 INJECTORES de ar (fundo)
CONTROLO remoto digital
PROGRAMAS de hidromassagem
SENSOR eletrônico do nível de água
SENSOR eletrônico de temperatura
SISTEMA de desinfecção
SISTEMA de cromoterapia (opção TOP)
REaquecedor de água (opção TOP)

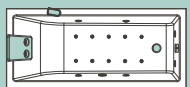

JET SET STAR Dorsal

6 INJECTORES orientáveis e reguláveis de água
8 a 10 INJECTORES de ar (fundo)
4 a 6 INJECTORES dorsais
APOIO de cabeça
CONTROLO remoto tátil
PROGRAMAS de hidromassagem
SENSOR eletrônico do nível de água
SENSOR eletrônico de temperatura
SISTEMA de desinfecção
SISTEMA de cromoterapia (opção TOP)
REaquecedor de água (opção TOP)

PROGRAMAS DE HIDROMASSAGEM

Os 4 programas de hidromassagem – antistresse, tonificante, desportivo e estético – permitem-lhe adaptar o poder relaxante e tonificante da massagem da água às suas necessidades específicas. Estão disponíveis nos sistemas **Jet Set Star** e **Jet Set Star Dorsal**.

CUBIC	244	PATRICIA	253	TREVO	260
CAROLINA	246	HELENA	254	OASIS	261
QUATTRO	247	ROSARIO	255	ÁREA	262
PLAZA	248	SARA	256	FATIMA	263
VITA	249	MARGARIDA	258	RUTE	264
NEXO	251	CLAUDIA	259	ISABEL	265
RAQUEL	252				

ANTISTRESSE 15M



De força média, é ideal para relaxar no final de um dia de grande esforço mental e físico.

TONIFICANTE 10M



Com uma intensidade progressiva, é um programa recomendado como preparação para um dia ativo.

DESPORTIVO 20M

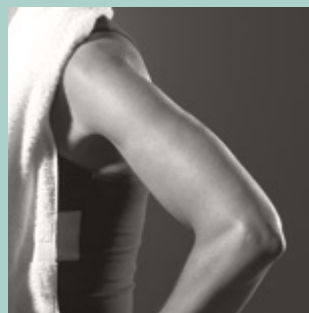

Com uma ação energética, foi concebido para após a prática desportiva, para relaxar os músculos.

ESTÉTICO 20M



Hidromassagem profunda com efeito anticelulítico, melhora a textura e suavidade da pele.

COMANDO TÁTIL

Os nossos sistemas programáveis - **JET SET STAR** - são acionados através de um prático comando estanque com amplo ecrã tátil, que permite controlar de forma simples e prática todas as funções de hidromassagem

CONTROLO TOTAL



Através deste prático comando tátil, poderá controlar de forma simples e cómoda todas as funções de hidromassagem da sua banheira.

AMPLIO ECRÃ TÁTIL



Com um ecrã de dimensões generosas retro-iluminado poderá desfrutar em pleno das capacidades da sua banheira.

SIMPLES E PRÁTICO



Graças a uma família de ícones ilustrativos das diferentes opções, irá facilmente aprender a controlar todas as funções de hidromassagem.

ESTANQUEIDADE TOTAL



Porque não faz sentido que se preocupe enquanto relaxa, o comando é perfeitamente estanque, podendo ser submerso sem dano.

MODELOS E ATRIBUTOS

BANHEIRAS ACRÍLICAS RECTANGULARES E OVAIS / GUIA RÁPIDO



CUBIC
Pág. 244



QUATTRO
Pág. 247



PLAZA
Pág. 248



VITA
Pág. 249



PACIFIC
Pág. 250

1900				1900 x 900	
1850					
1800	1800 x 800	1800 x 1000	1800 x 800	1800 x 900 1800 x 800	
1700	1700 x 800 1700 x 750 1700 x 700		1700 x 800		1700 x 750 1700 x 700
1600	1600 x 800 1600 x 750 1600 x 700				1600 x 750 1600 x 700
1500	1500 x 700				1500 x 700
1450					
1400	1400 x 700				1400 x 700
1300					
1200					
1050					

	HID Digital	•	•	•	•	•
	HID Dorsal	•	•	•	•	
	MULTIJET Digital	•	•	•	•	
	MULTIJET Dorsal	•	•	•	•	
	JET SET STAR	•	•	•	•	
	JET SET STAR Dorsal	•	•	•	•	
	Opção TOP	•	•	•	•	

MODELOS E ATRIBUTOS

BANHEIRAS ACRÍLICAS ANGULARES E EM AÇO ESMALTADO / GUIA RÁPIDO



MARGARIDA
Pág. 258



NEXO
Pág. 257



CLÁUDIA
Pág. 259









TREVO
Pág. 260



OÁSIS
Pág. 261

1800					
1700					
1600		1600 x 1000			
1500					
1450	1450 x 1450				
1400			1400 x 1400		
1370					
1350				1350 x 1350	
1300					1300 x 1300
1200					
1050					

	HID Digital	•	•	•	•	•
	HID Dorsal	•	•	•	•	
	MULTIJET Digital	•	•	•	•	•
	MULTIJET Dorsal	•	•	•	•	
	JET SET STAR	•		•	•	•
	JET SET STAR Dorsal	•		•	•	
	Opção TOP	•		•	•	•



ÁREA
Pág. 262



FÁTIMA
Pág. 263



RUTE
Pág. 264



ISABEL
Pág. 265



QUEEN
Pág. 268



EUROPA
Pág. 270



INFANTIL
Pág. 270



HOTEL
Pág. 271

				1800 x 800			
					1700 x 700		1700 x 750
					1600 x 700		1600 x 750
	1505 x 1005		1500 x 1500		1500 x 700		1500 x 750
1400 x 1400					1400 x 700		1400 x 750
		1370 x 1370					
					1300 x 700		
					1200 x 700		
						1050 x 700	

•	•	•	•				
•	•						
•	•	•	•				
•	•						
•	•	•	•				
•	•						
•	•	•	•				



CABINAS



HIDROSSAUNA

As cabinas equipadas com este sistema utilizam o inesgotável poder revitalizante do vapor de água, um aliado precioso para o bem-estar. Criando um ambiente quente e húmido, originam uma suave névoa de vapor que envolve todo o corpo, relaxando os músculos e eliminando toxinas.

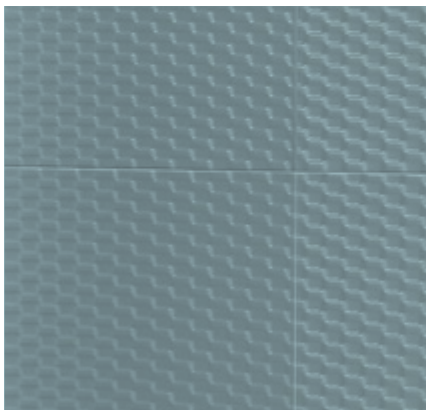
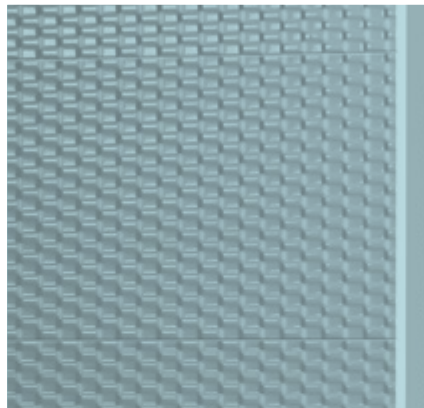
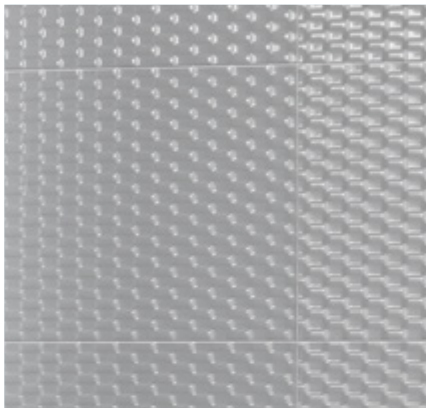
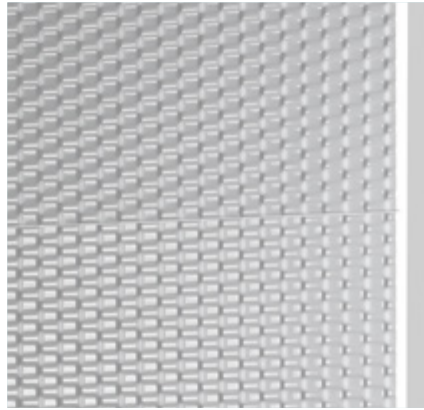

HIDROMASSAGEM

Todas as nossas cabinas proporcionam uma massagem completa por todo o corpo e/ou em áreas específicas, utilizando injetores reguláveis colocados em pontos estratégicos como a zona cervical, lombar, dorsal, coxas e/ou gêmeos.

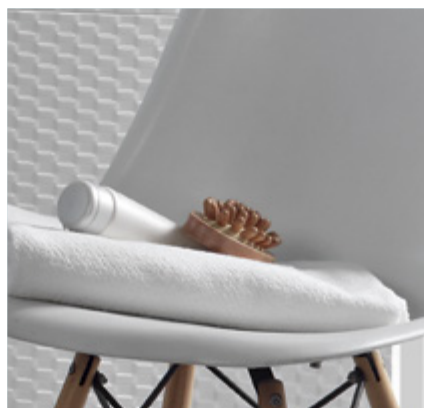



Cabina de hidromassagem SMART Wellness

SMART

BASIC / TECH / WELLNESS



+ SMART

MEDIDAS:

900 x 750 x 2135mm (apenas *Basic e Tech*)

1000 x 800 x 2135mm

1200 x 800 x 2135mm

CARACTERÍSTICAS:

Chuveiro superior de grandes dimensões e chuveiro de mão auxiliar

Resguardo de portas corrediças com vidros de segurança de 6mm

Painéis interiores em alumínio e perfis cromados

Banco em solid surface (opcional)

Estante porta-objetos

Instalação incluída no preço (*somente em Portugal*)

Garantia de 5 anos



Cabina de hidromassagem SMART Basic



Controlo tátil (Wellness)



Chuveiro superior



Injetores de massagem



Vapor / Aromaterapia (Wellness)



Pulverização

1 SMART

CARACTERÍSTICAS:

Pulverização (efeito banho turco)
8 Injetores orientáveis de massagem:
efeito *chuva* e *pulsante*
Misturadora termostática e seletor de 5 funções



2 SMART Tech

CARACTERÍSTICAS:

Pulverização (efeito banho turco)
8 Injetores orientáveis de massagem:
efeito *chuva* e *pulsante*
Painel de controlo tátil
Rádio e luz (LED)
Misturadora termostática e seletor de 5 funções



3 SMART Wellness

CARACTERÍSTICAS:

Pulverização (efeito banho turco)
8 Injetores orientáveis de massagem tripla função:
efeito *chuva*, *pulverização* e *pulsante*
3 climas de banho de vapor
Aromaterapia
Painel de controlo tátil
Rádio e luz (LED)
Misturadora termostática e seletor de 5 funções
Painéis interiores em alumínio e Corian®





Detalhe do duche da SMART Wellness



Detalhe da pulverização da cabina SMART Wellness



Detalhe da painel táctil da cabina SMART Wellness

MODELOS E INFORMAÇÃO

CABINAS DE HIDROMASSAGEM / PROGRAMAS E TERAPIAS

EXPERIÊNCIA DE BEM-ESTAR

Todas as nossas cabinas proporcionam uma massagem completa por todo o corpo e/ou em áreas específicas, utilizando injetores reguláveis colocados em pontos estratégicos como a zona cervical, lombar, dorsal, coxas e/ou gêmeos. As cabinas equipadas com o sistema de HIDROSSAUNA utilizam o inesgotável poder revitalizante do vapor de água, conhecido desde a antiguidade como um aliado precioso para o bem-estar. Criando um ambiente quente e húmido, originam uma suave névoa de vapor que envolve todo o corpo, relaxando os músculos e eliminando toxinas.

TERAPIAS

BANHO DE VAPOR



O banho de vapor, ou “banho turco”, é caracterizado por um ambiente quente e húmido. O vapor libertado provoca a transpiração e a desobstrução dos poros e eliminação de toxinas. É benéfico para problemas respiratórios, de retenção de líquidos ou pele seca, já que incentiva a drenagem linfática e a oxigenação do sangue.

SMART Wellness

CROMOTERAPIA



A cromoterapia é uma terapia milenar que assenta no tratamento de algumas doenças através das capacidades terapêuticas do uso simultâneo da luz e da cor. Com um carácter estimulante ou regenerativo, a cromoterapia promove o equilíbrio do corpo, a nível físico e mental.

SMART Wellness

AROMATERAPIA



A aromaterapia consiste na difusão através de vapor, de fragrâncias com propriedades terapêuticas. Os óleos essenciais são assimilados na circulação sanguínea, sendo um importante auxiliar no tratamento e prevenção de vários problemas físicos e psicológicos.

SMART Wellness

MODELOS E ATRIBUTOS

GAMA DE CABINAS DE HIDROMASSAGEM / GUIA RÁPIDO



SMART Basic

Pág. 280



SMART Tech

Pág. 280



SMART Wellness

Pág. 280

CARACTERÍSTICAS GERAIS			
Nº de injetores	8	8	8
PAINEL ELETRÓNICO			
Painel de controlo		Digital tátil	Digital tátil
Rádio		•	•
ILUMINAÇÃO			
Luz		•	•
Cromoterapia			
BANHO VAPOR			
Banho de vapor			•
Nº de climas de banho de vapor			3
Aromaterapia			•
SISTEMA DE PULVERIZAÇÃO			
Pulverização	•	•	•
HIDROMASSAGEM			
Nº de injetores (efeito pulsante)	8	8	
Nº de injetores (efeito chuva, pulsante e pulverização)			8
Nº de injetores cervicais (duche em pé / duche sentado)	2/2	2/2	2/2
Nº de injetores dorsais (duche em pé / duche sentado)	4/2	4/2	4/2
Nº de injetores gémeos (duche em pé / duche sentado)	2	2	2
Injetores orientáveis com sistema anti-calcário	•	•	•
ABERTURAS DE PORTAS			
Sistema de abertura de portas	Corrediço	Corrediço	Corrediço
MATERIAIS E ACABAMENTOS			
Base acrílica	•	•	•
Painéis em corian®			•
Perfis em alumínio acetinado			
Perfis cromados	•	•	•
Estante porta-objetos	1	1	1
POSSIBILIDADE DE INSTALAÇÃO			
Em canto	•	•	•
DIMENSÕES			
Rectangular (mm)	900 x 750 1000 x 800 1200 x 800	900 x 750 1000 x 800 1200 x 800	1000 x 800 1200 x 800

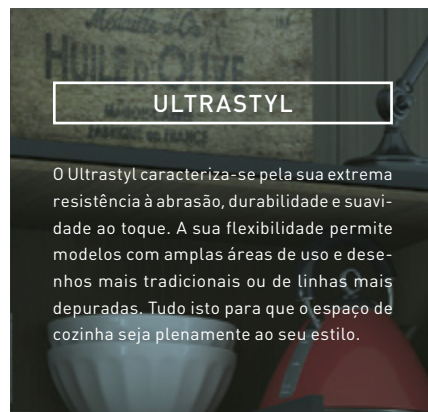

COZINHA

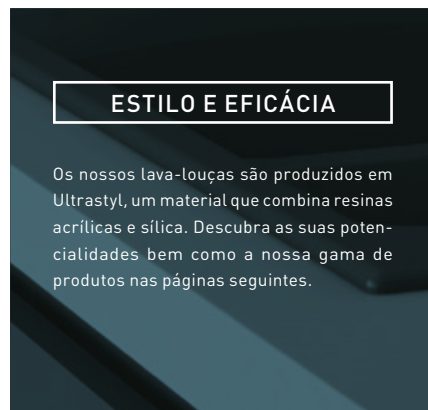
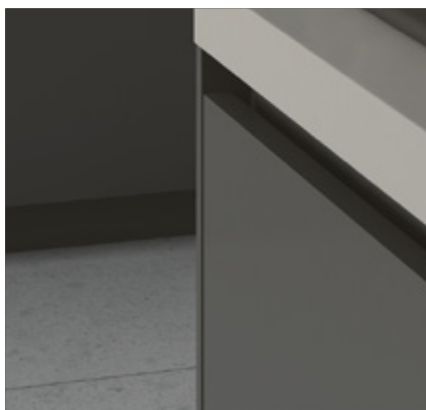

ULTRASTYL

O Ultrastyl caracteriza-se pela sua extrema resistência à abrasão, durabilidade e suavidade ao toque. A sua flexibilidade permite modelos com amplas áreas de uso e desenhos mais tradicionais ou de linhas mais depuradas. Tudo isto para que o espaço de cozinha seja plenamente ao seu estilo.

ESTILO E EFICÁCIA

Os nossos lava-louças são produzidos em Ultrastyl, um material que combina resinas acrílicas e sílica. Descubra as suas potencialidades bem como a nossa gama de produtos nas páginas seguintes.

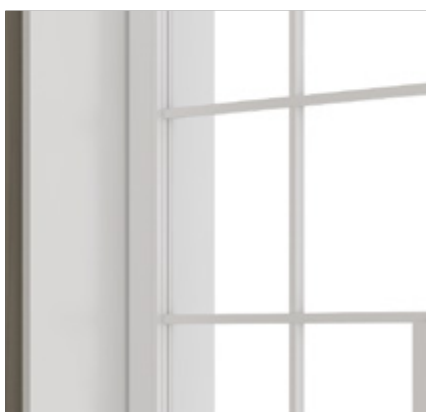

TORNEIRAS

As nossas torneiras de cozinha vêm equipadas com cartuchos cerâmicos normais ou cartuchos ecológicos e ainda, em alguns casos, chuveiros flexíveis ou retráteis de 2 funções. Estão disponíveis numa variedade de estilos e foram pensadas para lhe dar o máximo de conforto no uso.



Lava-louça AMÉRICA com cuba e lava-legumes em cor antracite com torneira UNIC para cozinha

AMÉRICA

3 FORMATOS

+ AMÉRICA

APLICAÇÃO:

Encastre por cima

FORMATOS E MEDIDAS:

1 Cuba e lava-legumes (838 x 559 x 221mm)

2 Cubas (838 x 559 x 230mm)

1 Cuba (635 x 559 x 221mm)

CARACTERÍSTICAS:

Válvula e sifão em inox incluídos

CORES:

Antracite

Cinza granito

Cinza prata

Branco

Branco granito

Creme

Bege granito





Lava-louça AMÉRICA com cuba e lava-legumes em cor antracite com torneira UNIC para cozinha



Lava-louça AMÉRICA com cuba em cinza prata

1 AMÉRICA

MEDIDAS:
838 x 559 x 221mm
CARACTERÍSTICAS:
Cuba e lava-legumes



2 AMÉRICA

MEDIDAS:
838 x 559 x 230mm
CARACTERÍSTICAS:
2 Cubas



3 AMÉRICA

MEDIDAS:
635 x 559 x 221mm
CARACTERÍSTICAS:
1 Cuba



BRASIL

3 FORMATOS



Lava-louça BRASIL com cuba, escorredor e lava-legumes em cor antracite com torneira TUBE Tech para cozinha

1 BRASIL

MEDIDAS:
1160 x 500 x 210mm
CARACTERÍSTICAS:
2 Cubas e escorredor



2 BRASIL

MEDIDAS:
990 x 500 x 214mm
CARACTERÍSTICAS:
Cuba, escorredor e lava-legumes



3 BRASIL

MEDIDAS:
860 x 500 x 210mm
CARACTERÍSTICAS:
Cuba e escorredor



+ BRASIL

APLICAÇÃO:

Encastre por cima

FORMATOS E MEDIDAS:

2 Cubas e escorredor (1160 x 500 x 210mm)

1 Cuba, lava legumes e escorredor (990 x 500 x 214mm)

1 Cuba e escorredor (860 x 500 x 210mm)

CARACTERÍSTICAS:

Válvula e sifão em inox incluídos

Reversíveis

CORES:

Antracite

Cinza granito

Cinza prata

Branco

Branco granito

Creme

Bege granito



Lava-louça BRASIL com cuba, escorredor e lava-legumes em cor branca com torneira TUBE Tech para cozinha

EUROPA

6 FORMATOS



Lava-louça EUROPA branco com cuba e escorredor e torneira SILK para cozinha

1 EUROPA

MEDIDAS:
1180 x 510 x 208mm
CARACTERÍSTICAS:
2 Cubas e escorredor



2 EUROPA

MEDIDAS:
980 x 510 x 208mm
CARACTERÍSTICAS:
2 cubas e lava-legumes



3 EUROPA

MEDIDAS:
980 x 510 x 208mm
CARACTERÍSTICAS:
Cuba, lava-legumes e escorredor



4 EUROPA

MEDIDAS:
800 x 510 x 208mm
CARACTERÍSTICAS:
2 Cubas



5 EUROPA

MEDIDAS:
890 x 510 x 208mm
CARACTERÍSTICAS:
Cuba e escorredor



6 EUROPA

MEDIDAS:
510 x 510 x 200mm
CARACTERÍSTICAS:
Cuba circular



+ EUROPA

APLICAÇÃO:

Encastre por cima

FORMATOS E MEDIDAS:

2 Cubas e escurredor (1180 x 510 x 208mm)

2 Cubas e lava-legumes (980 x 510 x 208mm)

1 Cuba, lava-legumes e escurredor (980 x 510 x 208mm)

2 Cubas (800 x 510 x 208mm)

1 Cuba e escurredor (890 x 510 x 208mm)

1 Cuba circular (510 x 510 x 200mm)

CARACTERÍSTICAS:

Válvula e sifão em inox incluídos

Reversíveis

CORES:

Antracite

Cinza granito

Cinza prata

Branco

Branco granito

Creme

Bege granito

Fumado alentejo



Lava-louça EUROPA com cuba e escurredor em cor cinza prata com torneira SILK para cozinha



Torneira TUBE Tech com bica flexível para cozinha aplicada com lava-louça BRASIL em cor antracite

TUBE TECH

COZINHA

TUBE Tech

CARACTERÍSTICAS:
Monocomando para cozinha
Cartucho cerâmico, bica flexível
e chuveiro de 2 funções incluídos
Corpo superior flexível

UNIC

COZINHA



Torneira UNIC de cano alto para cozinha

+ UNIC

CARACTERÍSTICAS:
Monocomando de cano alto para cozinha
Cartucho cerâmico incluído
Perlator orientável 7°
Corpo superior rotativo

FLOW

COZINHA

+ FLOW

CARACTERÍSTICAS:

Monocomando para cozinha
Cartucho cerâmico ecológico e
chuveiro retrátil de 2 funções incluídos
Corpo superior rotativo



Torneira FLOW para cozinha em modo chuveiro e modo spray



Torneira TUBE para cozinha

TUBE

COZINHA

+ TUBE

CARACTERÍSTICAS:

Monocomando para cozinha
Cartucho cerâmico incluído
Corpo superior flexível



Torneira SILK para cozinha

SILK

COZINHA

+ SILK

CARACTERÍSTICAS:
Monocomando para cozinha
Cartucho cerâmico ecológico *due* incluído
Corpo superior rotativo



Torneira NOA para cozinha

NOA

COZINHA

+ NOA

CARACTERÍSTICAS:

- Monocomando para cozinha
- Cartucho cerâmico ecológico *due* incluído
- Corpo superior rotativo

BRASIL

COZINHA

1 BRASIL

CARACTERÍSTICAS:

- Monocomando para cozinha
- Cartucho cerâmico incluído
- Corpo superior rotativo

2 BRASIL De parede

CARACTERÍSTICAS:

- Monocomando de encastre para cozinha
- Cartucho cerâmico incluído
- Corpo superior rotativo



Torneira BRASIL para cozinha



Torneira ATLAS 40 para cozinha

ATLAS 40

COZINHA

1 ATLAS 40

CARACTERÍSTICAS:

Monocomando para cozinha
Cartucho cerâmico *due* incluído
Corpo superior rotativo

2 ATLAS 40 Cano alto

CARACTERÍSTICAS:

Monocomando de cano alto para cozinha
Cartucho cerâmico *due* incluído
Corpo superior rotativo

XS

COZINHA

+ XS

CARACTERÍSTICAS:

Monocomando para cozinha
Cartucho cerâmico incluído
Bica longa: 21cm



Torneira XS para cozinha

CARACTERÍSTICAS

GAMA DE LAVA-LOUÇAS / GUIA RÁPIDO

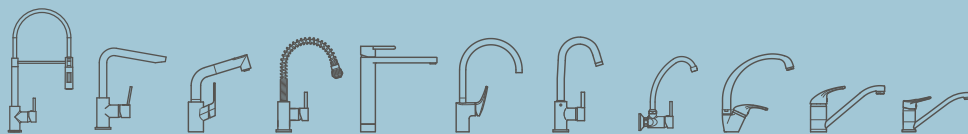

	TUBE Tech Pág. 296	UNIC Pág. 297	FLOW Pág. 298	TUBE Pág. 298	SILK Pág. 299	NOA Pág. 300	BRASIL Pág. 300	BRASIL Pág. 300	ATLAS 40 Pág. 301	ATLAS 40 Pág. 301	XS Pág. 301
APLICAÇÃO Bancada	•	•	•	•	•	•	•		•	•	•
APLICAÇÃO Parede								•			
CORPO SUPERIOR Rotativo	•	•	•	•	•	•	•	•	•	•	•
CARTUCHO Cerâmico	•	•	•	•			•	•	•	•	•
CARTUCHO Cerâmico - Ecológico					•	•					
CHUVEIRO 2 Funções	•		•								
BICA Flexível	•			•							

+ CARTUCHOS

Discos cerâmicos

Componentes essenciais de qualquer torneira, os cartuchos são peças cilíndricas estanques que encaixam no corpo da torneira. São compostos por 2 discos: 1 fixo e 1 móvel. É pelo condicionamento da posição do disco móvel, feito através do manípulo, que se regula o fluxo da água bem como a temperatura. A Sanitana equipa as suas torneiras com discos cerâmicos, duradouros e resistentes, o que permite aumentar a eficácia e longevidade da torneira.

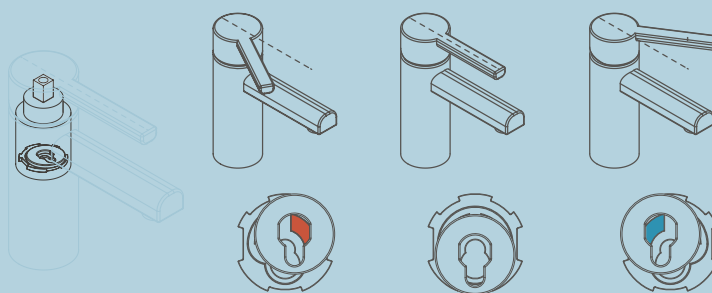

+ CARTUCHOS

Ecológicos

Porquê usar o fluxo máximo de água quando metade basta? O cartucho ecológico de discos cerâmicos foi desenhado com a poupança em mente. Através de um sistema que condiciona a abertura do manípulo a 2 tempos – 50% de fluxo de água com meia abertura do manípulo e 100% com abertura total. A pequena resistência que sentirá ao elevar o manípulo é sinal da ativação do sistema ecológico.



1 ABERTURA 50%

50% do fluxo
Modo ecológico



2 ABERTURA 100%

100% do fluxo de água
Modo convencional

MODELOS E MEDIDAS

LAVA-LOUÇAS E TORNEIRAS PARA COZINHA / GUIA RÁPIDO

AMÉRICA

Página 290

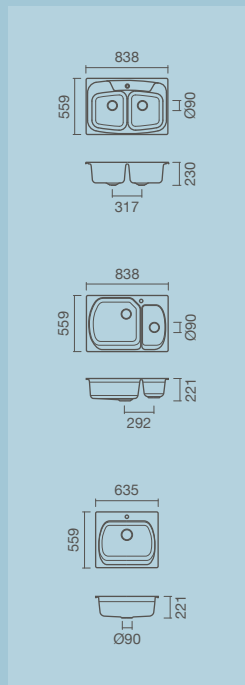

BRASIL

Página 292

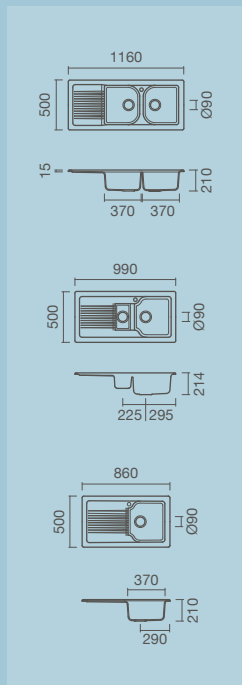

EUROPA

Página 294

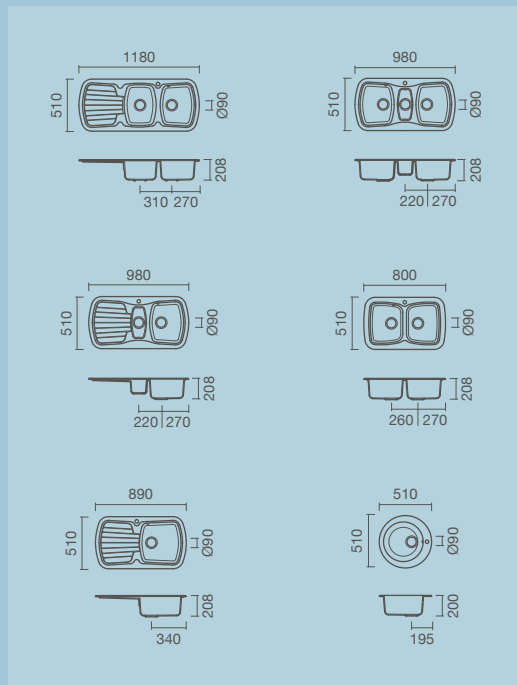

TUBE Tech

Página 296

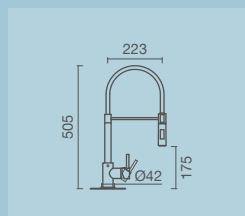

UNIC

Página 297

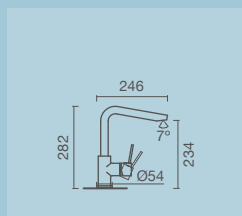

FLOW

Página 298

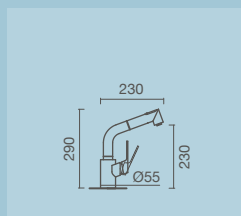

TUBE

Página 298

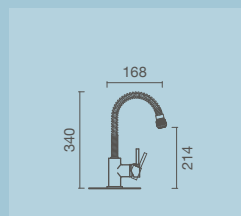

SILK

Página 299

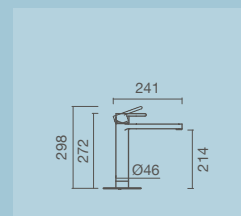

NOA

Página 300

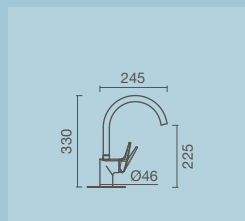

BRASIL

Página 300

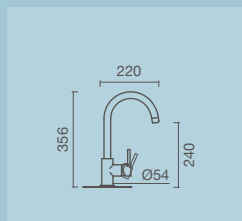

ATLAS 40

Página 301

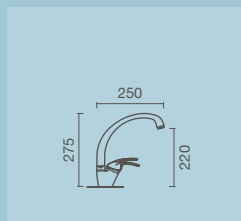

ATLAS 40

Página 301

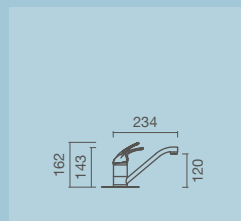

XS

Página 301

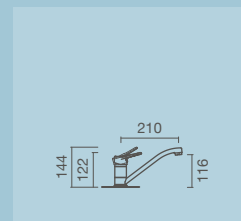



Todas as medidas dos desenhos técnicos estão em milímetros, salvo indicação em contrário. As medidas e cores são a título orientativo. Por razões técnicas ou comerciais, a SANITANA reserva-se o direito de introduzir modificações aos preços, materiais, acessórios ou outras especificações sem aviso prévio. Os produtos fotografados podem não corresponder exatamente ao produto final devido ao conceito gráfico do catálogo. Textos redigidos ao abrigo do novo acordo ortográfico.



SANITANA, FÁBRICA DE SANITÁRIOS DE ANADIA S.A.

Zona Industrial de Anadia, Apartado 45 | 3781-909 Anadia (Portugal)

E-MAIL: info@sanitana.com | **TEL:** +351 231 519 500 | **FAX:** +351 231 511 504

www.sanitana.com | www.sanitanaprofissional.com

ASSISTÊNCIA TÉCNICA

TEL: +351 231 519 515 | **FAX:** +351 231 519 504

E-MAIL: assistencia.sanitana@sanitana.pt